

Wilkhahn

Catalog

Wilkhahn. Design at work.
Chairs, tables and much more.



Wilkhahn. Design at work.

Founded one hundred years ago, the Bauhaus influenced modernism significantly. The Bauhaus and later Ulm University of Design with its similar approach also played key roles in our own design development. Close collaboration with both organizations taught us valuable lessons in research, methods, materials and technologies, allowing us to set milestones to help us progress again and again. These roots and our commitment to better design connect us with artists, architects, designers and customers around the world. This background inspires us to collaborate with others to reinterpret modernism's holistic design approach to meet new challenges time after time.

Today, the power of good design is more important than ever. Because how can we wed the flexibility and diversity of modern working environments with sustainability, continuity and identity? We've spent decades developing a design language to make highly attractive products that are also simple, honest and break new grounds in terms of practicality. Each detail is important to the distinctive look of the finished item. Therefore, in the spirit of the Bauhaus founders, a clear vision for the future is apparent in each and every product. Perhaps you'll sense the power of good design when leafing through this Wilkhahn catalog.

A handwritten signature in black ink, appearing to read 'Jochen Hahne', with a long, sweeping horizontal stroke at the end.

Dr Jochen Hahne, President

A holistic design approach

The architecture at the Wilkhahn site reveals the impact of modernism. From the rectangular management building based on plans by Bauhaus student Herbert Hirche to the unique production pavilions by Pritzker Prize winner Frei Otto to Thomas Herzog's award-winning hall architecture.





The idea of incorporating economy, ecology, aesthetics and a people-friendly workplace spawned the four pavilions, which aren't just architectural gems, but also offer outstanding conditions for the demanding work done by the sewing and upholstery teams.



The group of production facilities is visible from afar and stands for the essential qualities of long-lasting product design: authentic materiality, sophisticated construction and a detailed aesthetic.



Left: In 1992, timber structures, green roofs, plenty of daylight and innovative solar technology set new standards in sustainable industrial architecture – and look just as contemporary today as they did back then.

Right: The management building was completed with floor-to-ceiling glazing in the CEO's office in 1959 – an expression of a new corporate culture characterized by transparency and collaboration.





The 21A stackable chair by architect, urban planner and designer Roland Rainer was produced between 1958 and 1966. The A-shaped frame made of solid beech made it possible to stack large numbers of chairs on top of one another.
→ **Aula**, page 67

On trend again today, the 457 upholstered furniture range had a home-like appeal in offices and local government buildings, 1959 – 1961, design: Herbert Hirche.



These were the first Wilkhahn chairs with plastic shells. Georg Leowald took the basic models from the 1950s to develop a diverse portfolio of products ranging from stackable four-leg to task chairs. → **Occo**, page 79



Developments ahead of their time.

New developments in materials, technologies, usage concepts and social trends repeatedly inspire us to identify what's missing and make existing products even better. The way that milestones have developed over the last 70 years show just how far ahead of our time we've always been.



Fiberglass and aluminum enabled us to make integrative forms and delicate structures and tap into new potential. The 1200 seating unit for waiting and transit areas still features in many subway stations. 1968 – 1988, design: Friso Kramer.



The 400 laminated wood range was produced from 1961 to 1998 and its distinctive "tennis racket throat" turned it into a bestselling, lightweight, flexible and comfortable multipurpose chair, design: Wilhelm Ritz.
→ **Aline**, page 63

With its large plastic shell, first-class materials and luxurious upholstery, Delta Design's 2000 chair range was ideal for contemporary executive offices and spaces where a prestigious look was paramount (1968 – 1989).
→ **Graph**, page 51





Architect and designer Georg Leowald initially believed he could meet all seating requirements with two types of shell and frame. People's desire for customization led to a variety of versions of the shell, upholstery and frame.

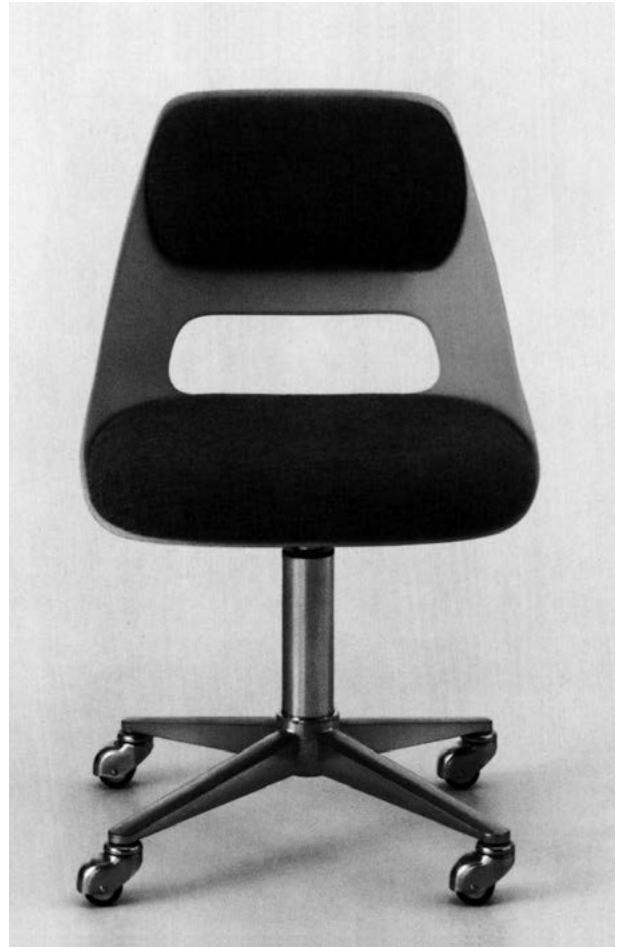

The last Leowald chair model from 1967 to 1972 offered a minimalist approach to the materials used, aesthetic transparency and kept backs cooler – and with casters on the base it could also be used as an office chair. → **Occo and Occo SC**, page 79

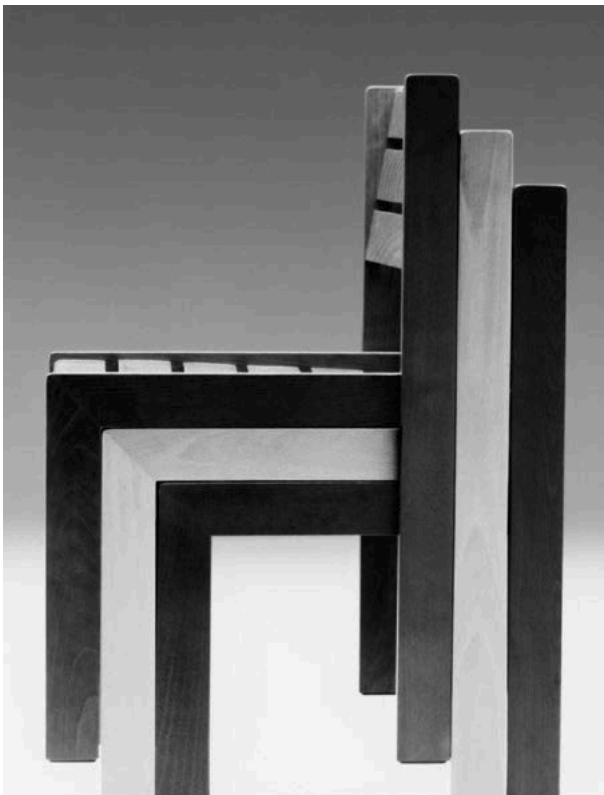

Archetypal sturdy and stackable multipurpose chairs made of wooden slats with hundreds of thousands produced and sold between 1965 and 1990. 300 range, design: Hans Peter Piehl. → **Ceno**, page 71

Designed by Wilhelm Ritz, this 232 office chair range with its flexible integrated backrest became an office chair bestseller and was sold from 1971 to 1990. Today, it's a collector's item particularly popular with the younger generation who like to park it at their desks.

→ **FS-Line**, page 47





The 190 chair range, designed by ProduktEntwicklung Roericht, provided dynamic flexibility with its three-part seat and backrest shell made of fiberglass-reinforced polyester without any mechanical parts required and incorporated in the structure. Produced from 1976 to 1983. → **Intra**, page 55



The futuristic design of Delta Design's 238 range (1976 – 1985) made a memorable impression in the James Bond movie *Moonraker*. And was an important precursor to the first international Wilkhahn bestseller. → **FS-Line**, page 47

The 840 range, produced between 1980 and 1998 by Ulm design studio ProduktEntwicklung Roericht, provided firmly upholstered sectional seating that could be linked in a variety of ways – long before this type of design was rediscovered for new workspaces. → **Insit**, page 91





The FS-Line, developed by Klaus Franck and Werner Sauer, has been making furniture history since 1980. It made healthy, dynamic sitting the new standard for office chairs worldwide – the easy-to-use, robust and understated classic is probably the most sustainable office chair today and more contemporary than ever. → **FS-Line**, page 47



Wilkahn created new trends with its mesh-based O-Line by the designer and last director of Ulm University of Design, Herbert Ohl. Instead of generous upholstery, this chair comes in an organic shape with a lightweight and transparent sophistication, produced from 1982 to 1995. → **Aline**, page 63



The innovative combination of wooden frame and ergonomically shaped backrest shell made of perforated plastic opened up new design options. The Kendo range from ProduktEntwicklung Roericht brought a breath of fresh air to meeting and recreation areas (1988 to 2006).
→ **Occo**, page 127

The stackable Thema table system, designed by Klaus Frank, Werner Sauer, Rainer Grabe and wiege, heralded a new chapter in the versatile design of conference and meeting rooms. All elements used to connect parts of the table were integrated into the attractive, top-quality under-frames for the first time. (1986 – 2007). → **Contas**, page 111





Nick Roericht had already developed the one-legged Ulmer Pulmer in 1976. Since 1992, the Stitz 2, designed by ProduktEntwicklung Roericht, has been ensuring people adopt healthy changes of posture now and then – long before these sitting-standing stools became mainstream. → **Stitz 2**, page 101



Designed to last and last, but still highly versatile – the Palette table range, designed by Karlheinz Rubner, went into production in 1992. → **Palette**, page 115

PER with Burkhard Schmitz and Franz Biggel designed in 1992 Picto, the world's first office chair to be consistently developed in line with ecological design principles. Produced until 2010, it was exemplary of ecological change at Wilkhahn and awarded the German Environmental Prize in 1996.





The company's goal to foster innovative processes led to the Confair range back in 1994 and established the new generation of dynamic conference furniture worldwide. Design: Fritz Frenkler, Justus Kolberg and wiege, folding table: Andreas Störiko. → **Confair**, page 103



By evolving ecological design principles under the banner of reduce to the max, Klaus Franck, Werner Sauer and wiege came up with a second ingenious task chair range in 1994. The Modus range is still regarded as the aesthetic benchmark for dynamic sitting. → **Modus**, page 39



Integrative design – the sum of its parts.

The step from the diversity of new working environments to ones that lack character isn't far. Which is why we've chosen an integrative design concept. Nowadays, cutting-edge design and manufacturing processes mean we can also create furniture that looks seamless. Therefore, understanding how to use our products is easier, complexity is reduced and they have a strong emotional appeal. These types of furniture can be used on their own or combined with each other in all sorts of ways and leave lasting impressions. And they reflect new workplace trends too.



Fluid lines, seamless transition points and different material thicknesses turn the cantilever chair into a modern seating sculpture. These features are also echoed in future table design and create a striking overall impression.

→ **Metrik**, page 75



1 → Graph, p. 51 → Graph tables, p. 123



2 → FS-Line, p. 47 → Timetable, p. 107



3 → Sitzbock, p. 97

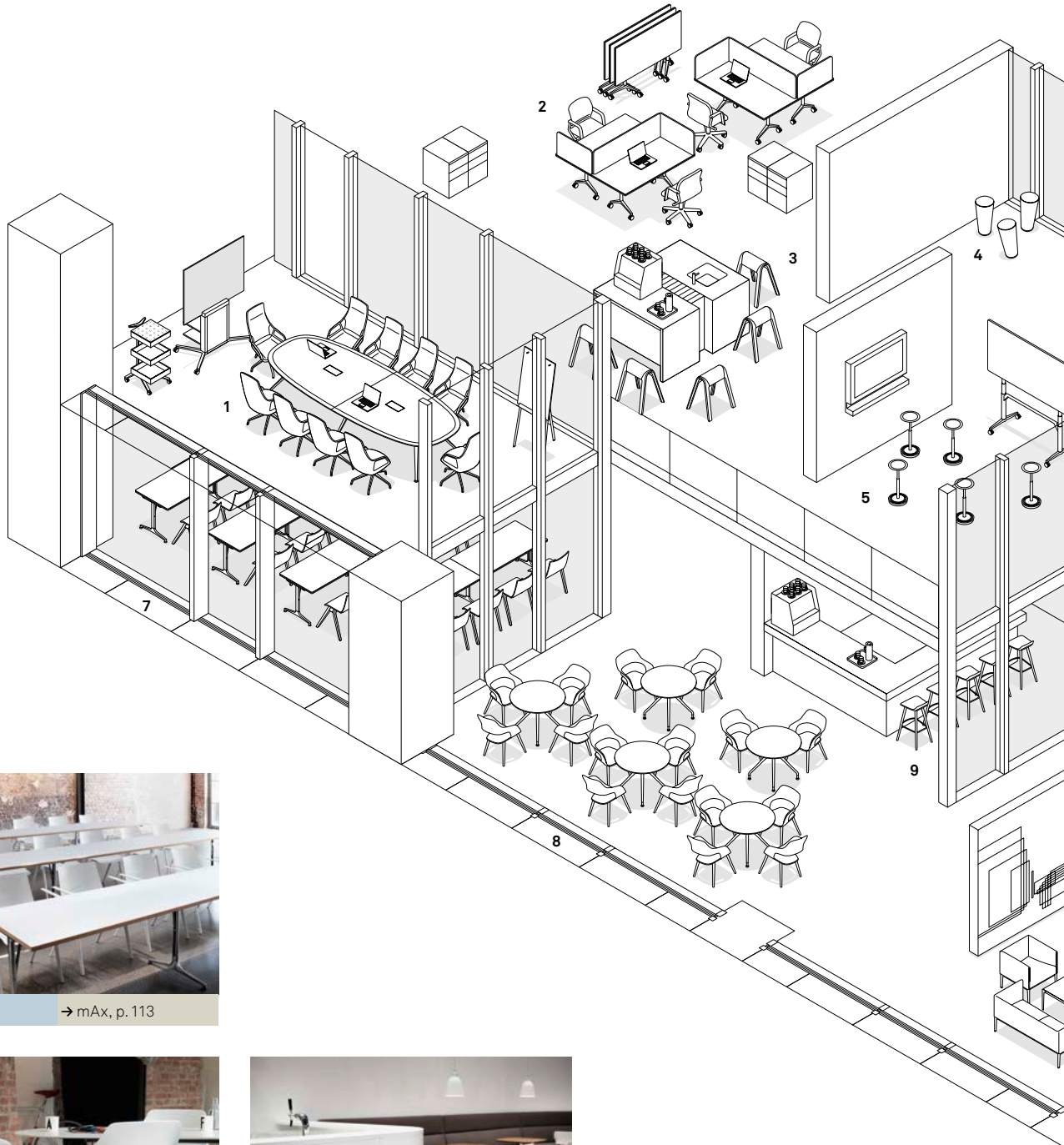

7 → Aula, p. 67 → mAx, p. 113



8 → Occo, p. 79 → Occo table, p. 127



9 → Occo, p. 79



4
→ Stand-up, p. 99



5
→ Stitz 2, p. 101 → Timetable Lift, p. 107



6
→ AT, p. 35 → Travis, p. 129

Design at work. At desks. In meetings. In break-out areas.

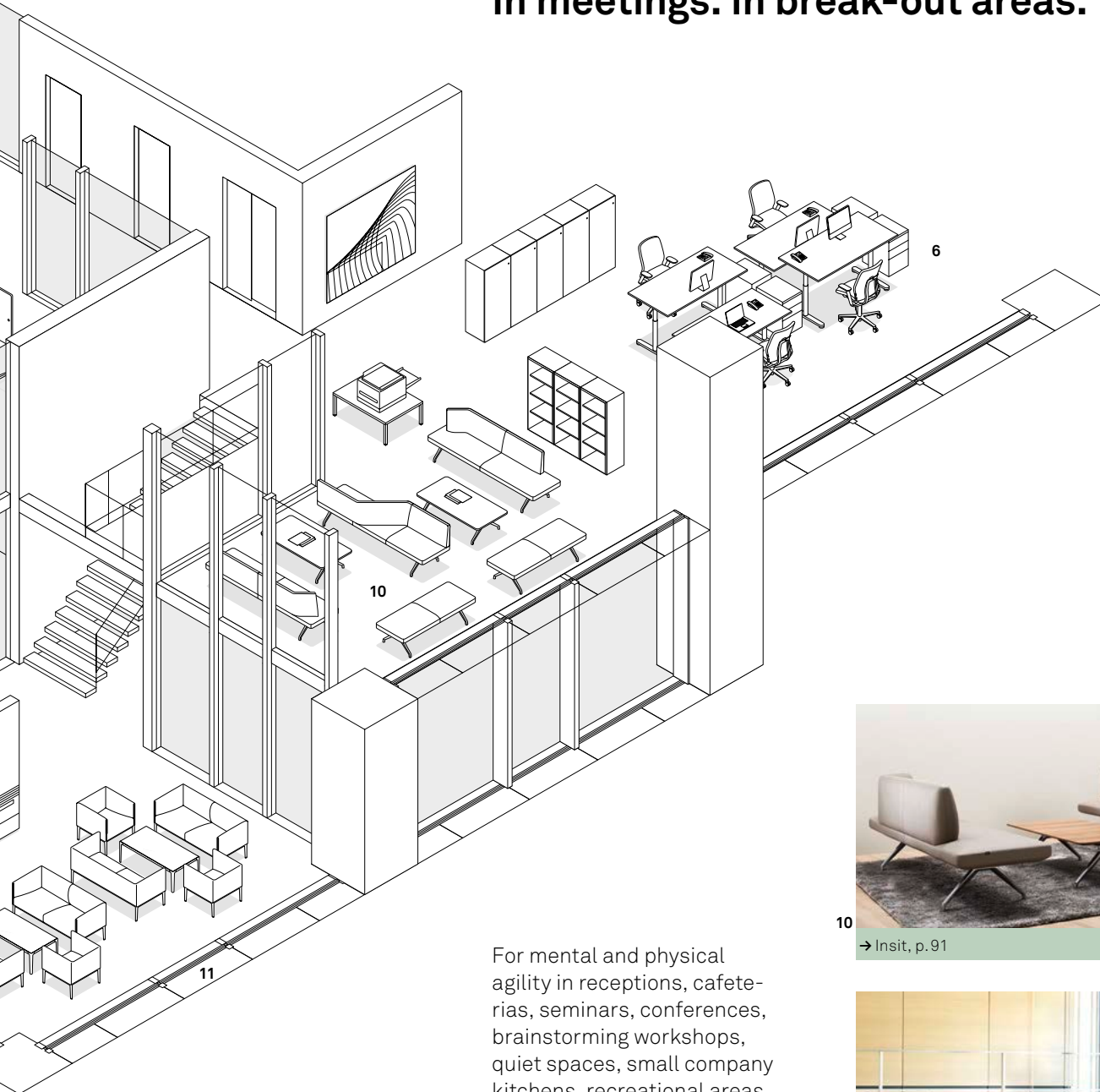

10
→ Insit, p. 91

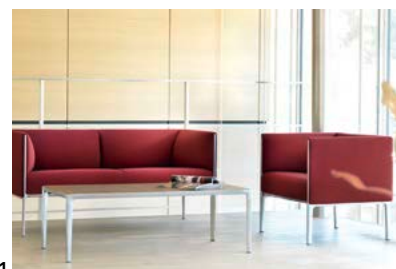

11
→ Asienta, p. 87

For mental and physical agility in receptions, cafeterias, seminars, conferences, brainstorming workshops, quiet spaces, small company kitchens, recreational areas, project workspaces and for people sitting at desks who need to concentrate.





■ Office chair ranges

Office seating: from the latest healthy 3D free-to-move ranges to the classic options for dynamic sitting.

Pages 24 – 49



■ Conference chairs

Our appealing, ergonomic chairs with a touch of prestige come in ranges or standalone models for contemporary conferences, and also cut a fine figure in executive boardrooms.

Pages 50 – 61



■ Multipurpose chairs

Skid-base, cantilever or four-leg chairs, made out of plastic, metal or wood, are ideal for dining, seminar or meeting spaces.

Pages 62 – 85



■ Sitting-standing stools

Smart seating for an occasional change of posture while talking to others or working, for activity-based breaks or team building.

Pages 94 – 101



■ Furniture for lounges, break-out areas and much more

From upholstery ranges and side tables to sectional seating and informal meet-up spaces – the right range for every purpose.

Pages 86 – 93



■ Dynamic tables

These ingenious space savers are considered the world's most attractive – tables that can be moved, folded or flipped up for conferences, project teams and seminars.

Pages 102 – 109



■ Adaptable tables and table systems

Table ranges to just unlatch and move or fold up or out that can be converted, made bigger or smaller, or stowed away in just a few minutes.

Pages 110 – 115



■ Standalone tables and table systems

Side tables, tables to sit or stand at, single tables or ones linked to form systems, tables with four legs, T-shaped bases or columns, on glides, casters or with height-adjustable functionality respond to any requirement.

Pages 116 – 129

Power supply for tables, page 130





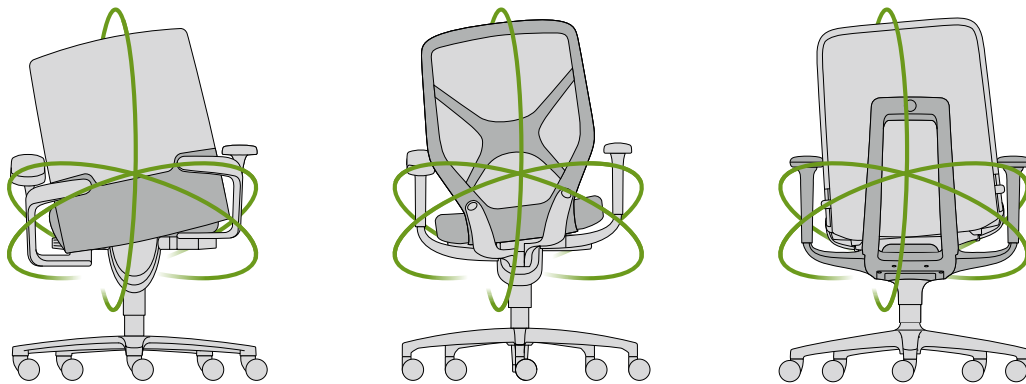

Free-to-move – exceptionally healthy 3D motion

We joined forces with the German Sport University Cologne and turned our three-dimensional, free-to-move ranges into a new standard. Underpinned by scientific analyses, our chairs are currently considered the best way of prompting healthy dynamic sitting. To respond to a variety of preferences and usage concepts, we've come up with three ranges to choose from: the generously sized classically stylish ON® office and conference chair, the sporty-athletic IN office chair, and the smart and broadly scalable AT all-rounder.



174/7
Task chair



175/7
Task chair



175/7
Task chair



174/1
Counter stool



171/7
Conference/
visitor chair



174/71
Task chair with manage-
ment grade upholstery



175/71
Task chair with manage-
ment grade upholstery



175/71
Task chair with manage-
ment grade upholstery



176/7
Conference/
visitor chair



178/7
Cantilever chair



178/7
Cantilever chair



178/71
Cantilever chair with
management grade
upholstery

Versions for 24-hour use are also available (174/8, 175/8, 174/81 and 175/81)



Bundespreis
ecodesign
Produkt 2012



mixology¹⁰

Not all awards apply to all types.



ON

170 range, design: wiege



The classic free-to-move chair range with a prestigious look and feel and a consistent design language for healthy 3D sitting at desks, in meetings and conferences.

The range is the latest milestone in global office chair development. Patented Trimension® technology has, for the first time, succeeded in synchronizing three-dimensional flexibility with our bodies to effectively prevent backache while we're sitting down. The multi-award-winning, high-quality design, the ease of use and the variety of models check virtually all the boxes. Three backrest heights are adjustable by 60 mm (medium-high, high and advanced height with headrest), three upholstered types (Fiberflex, extra padding and management grade upholstery) and three types of 3D armrest add up to 27 basic designs for the task chairs alone.





Model 175/71 with headrest



Model 184/7



184/7
Task chair



184/7
Task chair



184/7
Task chair



184/1
Counter stool

As 184/8 model, also available for 24-hour use.



reddot award 2015
winner



GERMAN
DESIGN
AWARD
SPECIAL
2016



Gold Award
contract



certified by Eurocom
ActiveOffice
AWARD



DESIGN
AWARD
2016

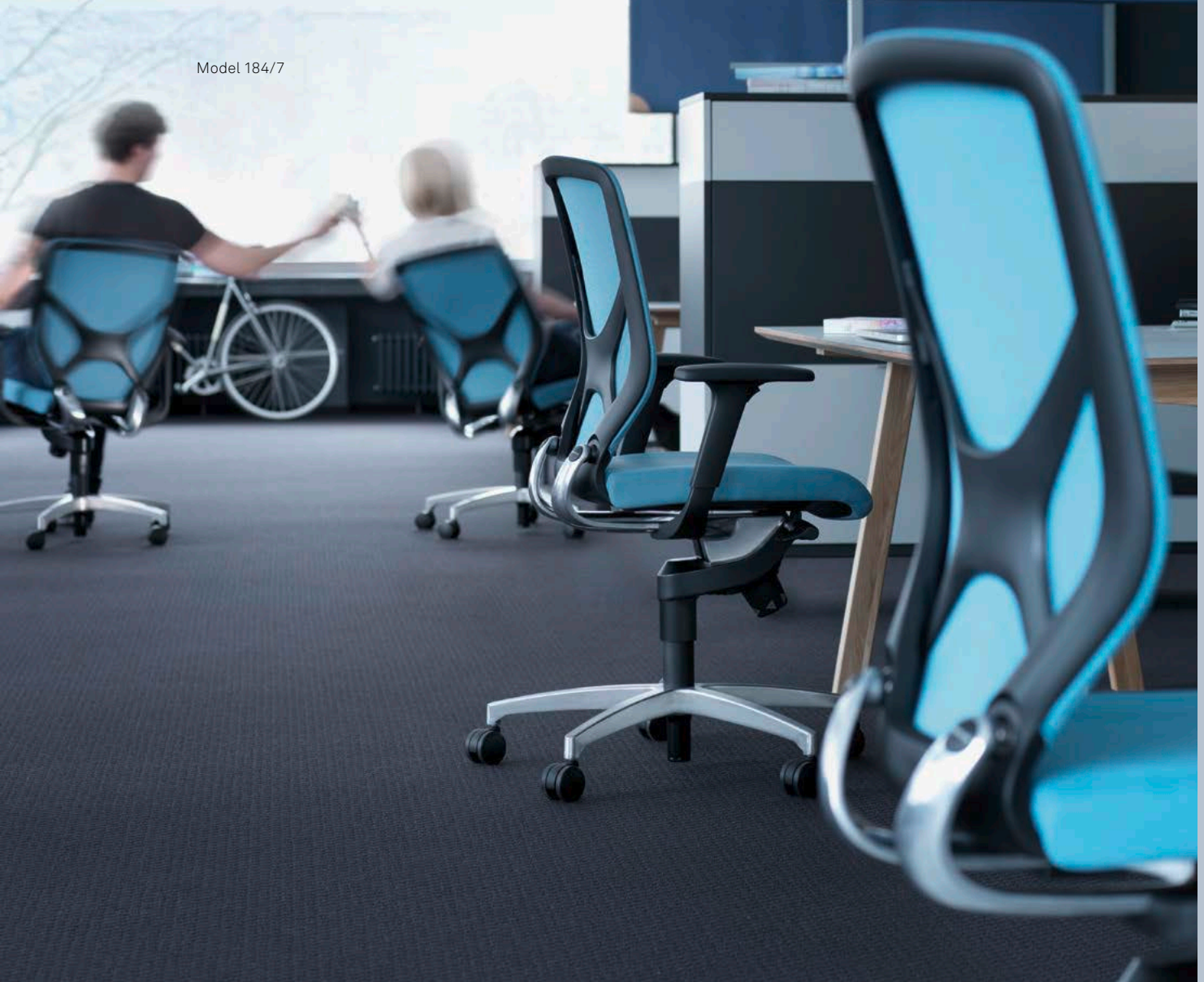

IN

184 range, design: wiege



From stylish to expressive, these athletic masters of motion are for people on the lighter or heavier side who spend a lot of their day sitting at computers.

Scientific studies have proved that the most dynamic free-to-move chair stimulates key muscles in the back while office workers are sitting down. The two swivel arms move independently of one another, interacting perfectly with the black or white seat and backrest element, which is made of cutting-edge two-component technology and has a 3D Formstrick cover. Body and chair merge to become a unit that's flexible in all directions – and users can activate a forward tilt option too. The counter pressure can be adjusted to people weighing up to 140 kg. In addition to the design options, it goes without saying that all the practical adjustment options for armrests, lumbar support and seat depth are available as well.







187/7
Task chair,
medium-height backrest



187/8
Task chair,
high backrest



187/9
Task chair, high backrest
with headrest and neck
rest



187/1
Counter stool



187/72
Task chair ESP
(elevated seating position)
to encourage sitting-
standing options, medium-
height backrest





Model 184/7

AT

187 range, design: Wilkhahn



The broadly scalable free-to-move all-rounder for the workspaces of today. It comes in a seminal design, a variety of models and is easy to use.

The fluid lines and molded seat-backrest shell are appealing from the get-go. The pioneering chair offers an enormous range of design options and empowers users to benefit from the freedom of movement offered. The self-centering suspension of the seat shell ensures that the body maintains its center of gravity at all times. The gray components with their icons make adjusting the chair intuitive and easy. And because the backrest bearer with its tilt capability has automatic weight adjustment, making use of the healthy range of motion is child's play. Just sit down, adjust the seating height and you're done! The chair and your body will do the rest by themselves.



Model 187/9



Model 187/7



263/7
Task chair,
standard height backrest



275/7
Task chair,
medium-height backrest



274/7
Task chair,
high backrest



277/7
Cantilever chair,
standard height backrest



281/5
Conference/visitor chairs,
standard height backrest



283/81
Task chairs,
standard height backrest



284/81
Task chairs,
high backrest



287/81
Cantilever chair,
standard height backrest



273/1
Counter stool



Not all awards apply to all types.



Model 275/7

Modus

26/27/28 range, design: Klaus Franck, Werner Sauer and wiege, Fritz Frenkler, Justus Kolberg

An office chair that reflects corporate culture and is ideal for reception areas or executive offices. It combines a sparing approach to the materials used in its production with maximum comfort and ground-breaking sustainability.

Almost a quarter of a century on, this classic chair is just as cutting-edge as on day one. The elasticity of the back, the firm upholstery with the cut-out sections at waist level and the stylish swivel arms that are part of the synchronous adjustment technology offer dynamic seating to perfection. The starter models in the 26 series have an upholstered, ergonomically shaped and hard-wearing backrest shell and the 27 compact series comes with three different backrest frame heights and cantilever chairs to match. The medium and executive 28 series with their broader seat widths, elegantly curved armrests and superb upholstery fulfill the most discerning of requirements for a prestigious look. All models offer a stylish aesthetic, excellent comfort and easy-to-replace covers and expendable parts to guarantee that the chairs last and last.



Model 284/81





181/6
Task chair,
medium-height backrest



181/6
Task chair,
medium-height backrest



181/6
Task chair,
medium-height backrest



181/71
Task chair,
medium-height backrest



183/3
Cantilever chair



183/3
Cantilever chair



183/3
Cantilever chair



183/5
Cantilever chair

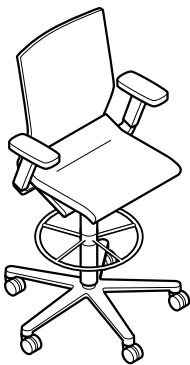

181/1
Counter stool

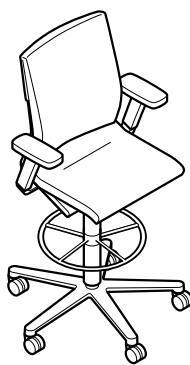

181/11
Counter stool



183
Four-wheeled trolley

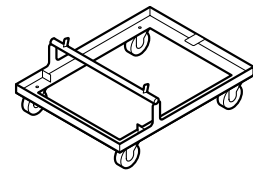

186
Four-wheeled trolley



Models 181/71 and 183/3

Neos office chair and cantilever chair

180 range, design: wiege

On its own or in a group – clear design, incredible comfort and ease of use make this furniture a laid-back understatement in all sorts of multipurpose spaces.

The attractively understated design harmonizes with virtually any backdrop and, depending on requirements, the chair comes with a height-adjustable backrest shell or covered backrest frame. Neos's defined shapes and contours, perfectly coordinated synchronous adjustment mechanism with large opening angle, suitability for people weighing between 40 to 120 kg, and its practical and very simple adjustment settings make it a multipurpose office chair for healthy dynamic sitting. It's good to know that the stackable cantilever chair with its consistent design down to the last detail and spacious comfort enhances any setting.







211/8
Task chair,
standard height backrest



213/8
Task chair,
high backrest



212/5
Cantilever chair,
standard height backrest



211/1
Counter stool



220/8
Task chairs,
medium-height backrest



220/9
Task chairs,
high backrest



220/92
Task chairs,
high backrest



Design Center
Stuttgart



Model 211/8

FS-Line and FS Management

21 range, design: Klaus Franck, Werner Sauer

A constant favorite due to its timeless form, vast range of motion, unbeatable quality and ease of use. It adapts to new workspace concepts and lifestyles again and again.

From seating for offices and meetings to cantilever chairs to the exclusive executive and conference chair range. The wide choice of models makes it easy to furnish all areas of a company with the famous classic office chair. The chair's hard-wearing nature and the simplicity with which its dynamic sitting feature is activated are still unparalleled today. The compact models are particularly popular for co-working spaces. The characteristically shaped shell with its replaceable cushions ensures the cantilever chair is superbly comfortable. And a range of frame surfaces, shells and covers in different colors respond to virtually any design requirements. Appealing, ergonomic, sturdy and easy to repair – a classic chair to last a lifetime.







301/5
Conference chair,
medium-height backrest



301/5
Conference chair,
medium-height backrest



301/7
Conference chair,
medium-height backrest,
height-adjustable



301/8
Conference chair,
medium-height backrest,
Active rocking mechanism



302/5
Conference chair,
high backrest



302/7
Conference chair,
high backrest

→ Graph tables, page 123



red dot design award
winner 2012



**INNOVATIONSPREIS
ARCHITEKTUR +
OFFICE**



Graph chairs

30 range, design: jehs+laub

With its groundbreaking form, innovative and stimulating comfort and attention to detail, this chair is a shooting star and classic for tomorrow's world and is guaranteed to appeal to users from the very beginning.

The Graph chairs aren't just encountered in lots of movies, but also in exclusive conference spaces and executive offices. Because what the seminal design promises is borne out the moment people sit on it. The fully covered and upholstered seat and backrest frames deliver superior sprung comfort. The haptics of the contoured die-cast aluminum frames and armrests are outstanding and the covers show superlative craftsmanship. They optionally come in two backrest heights, with glides or casters plus height adjustment or Active rocking technology to respond to almost any requirements.







295/6
Conference chair,
standard height backrest



295/7
Conference chair,
medium-height backrest



295/8
Conference chair,
high backrest



red dot



Intra

295 range, design: Phoenix Design

With a design that wouldn't look out of place in homes, this range's attractively integrated dynamic sitting capability and modern combinations of materials and colors reflect a collaborative and agile management culture.

The longer people spend in meetings, the greater the need for more agility in the seating to keep body and mind alert. A backdrop with a home-like appeal is also a good way of fostering trust and a team spirit. Which is why Intra's precision-adjustable height and synchronous adjustment mechanism with automatic weight adjustment has been concealed so that it's virtually impossible to spot. The synchro-adjustment mechanism and controls fuse almost invisibly with the seat shell and the elegantly integrated armrests to create a fluid form that indicates quality and respect for the people using the chair. Organic lines, precise transition points, modern color combinations and dynamic comfort make Intra the embodiment of a new type of management culture, which, thanks to three backrest heights, can be expressed in a whole host of areas ranging from desk-based workspaces or meetings to customer-service situations.



Models 295/6 and 295/7





291/7
Conference chair



291/7
Conference chair



291/71
Conference chair



291/71
Conference chair



291/71
Conference chair



Model 291/71

Sola

290 range, design: Justus Kolberg

The slimline contour, flat cushioning and distinctive frame with rocking capability make this chair ideal for modern conference spaces requiring a feeling of dynamism and structure.

The chair's attractive aesthetic is defined by the slender, clear shape of the seat body and the linear aluminum frame, which branches out into a V-shaped support and culminates in the armrests. The clever part is that the seat is swivel-mounted at the front and connected with a V-shaped support by two pressure springs at the rear. So the chair can be adjusted to rock backward and forward. The upholstered molded plywood seat shell is fully covered in high-quality fabrics or leather. The management-grade version comes with facings and cushion-like top stitching. This lends the chair a classy and subtly luxurious touch. The armrests can also come with extra, optional leather-covered armrest pads. Height-adjustable and optionally also on casters, Sola is at home in conferences, stylish company restaurants and meeting spaces, or home offices. (License through Davis Furniture).



Models 291/71, A customized version with floor-mounted chairs on runners and return spring.





230/1
Multipurpose chair



230/2
Multipurpose chair



232/1
Task chair



231/2
Visitor chair



230/6
Bar stool

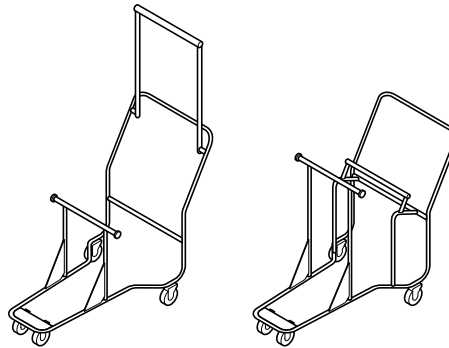

Accessories

Four-wheeled trolley for stacked chairs, inline connector (not pictured)



233/1
Multipurpose chair



233/1
Multipurpose chair



233/2
Multipurpose chair



233/4
Bar stool

→ Aline tables, page 119





Aline chairs

230 range, design: Andreas Störiko

This broad range of chairs offers delicate transparency and elastic comfort, keeps backs cool, and is very easy to handle

The stackable skid-base chair is the centerpiece of the stylish range. In conjunction with the chrome frame, the seat and backrest frame made of through-dyed, tough plastic add up to a lightweight, elastic, yet stable structure. And the cover made of transparent, high-performance fabric only enhances the superior comfort provided. The special shape of the skid-base seat frame allows very precise, reliable and easy stacking. In addition to types in black, white and gray, models with colored seat cushions are also available. A contact suppression feature in the swivel-mounted visitor and height-adjustable office chairs delivers extra comfort.



Models 230/1 and 230/2

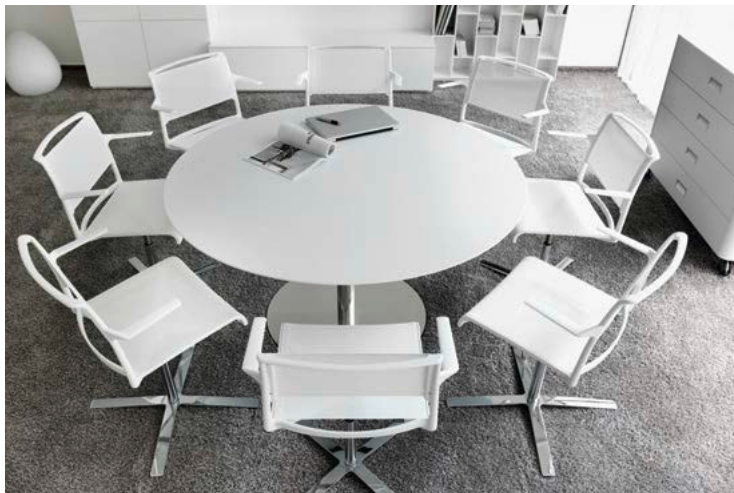

Model 232/2

Right: In the Aline S version, the skid-base chairs and bar stools are covered in finely grained and slatted black or white membranes, which can be replaced if needed. These eye-catching, practical and long-lasting chairs are ideal for areas like cafeterias, which are subject to lots of wear and tear. Just like their sister model, up to 15 skid-base chairs can be stacked on top of one another on the floor and up to 20 on the stacking trolley. Special glides allow models without or alternately with armrests to be joined up in rows. The chair alternatively comes with a seat shell and colored cushioning. By adding an optional stacking bumper, up to ten of them can be stacked.



Model 230/5



Model 233/1

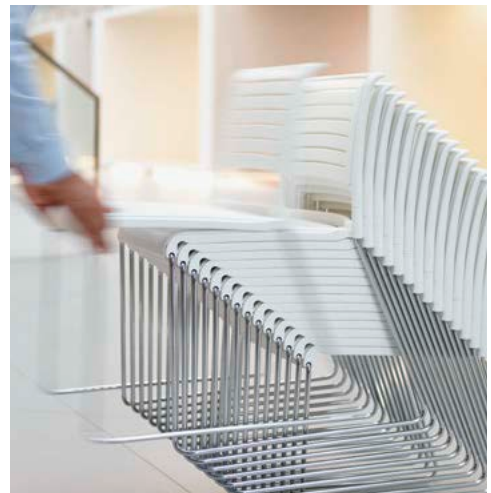



238/10
Multipurpose chair,
not upholstered,
without armrests



238/10
Multipurpose chair,
not upholstered,
with armrests



Up to 16 stackable
free-standing



238/12
Multipurpose chair,
with seat cushioning,
without armrests



238/11
Multipurpose chair,
with seat cushioning
and armrests



238/13
Multipurpose chair,
fully upholstered,
with armrests

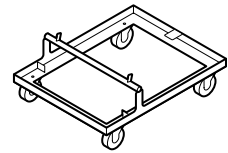

186
Stacking trolley



reddot award 2018
winner



Model 238/10

Aula

238 range, design: Wolfgang C.R. Mezger

This lightweight, stackable chair with its organic lines is made out of high-tech plastic. It's molded to perfection and offers lots of colors and upholstery options, making it an item of furniture that goes anywhere.

Our Aula multipurpose chair took plastic as a material to a new aesthetic and functional level. This practical, easy-care, all-plastic chair has a consistent design language because the colors and surfaces are the same. Its precise lines and the way the base frame, armrests and seat shell fuse with the rest of the structure suggest an organic sculpture. The form, elasticity and ergonomic design of the seat shell provide remarkable support and comfort, even when people of all shapes and sizes sit on it for long periods of time. With five colors, four upholstery types and sophisticated accessories, it's ideal for all sorts of settings such as multipurpose spaces, cafeterias, conference centers and seminar, meeting or co-working spaces where linkage and stacking options are a must.



Model 238/10, up to 16 can be stacked
free-standing.





361/5
Conference chair,
medium-height backrest



361/5
Conference chair,
medium-height backrest,
up to eight stackable



361/6
Conference chair,
medium-height backrest



362/5
Conference chair,
high backrest





Model 361/5

Ceno

361 range, design: Läufer + Keichel

This comfortable, high-quality and stackable item can change settings and looks to coordinate with company restaurants or conference and seminar spaces.

The elegantly shaped aluminum frame and the contours of the seat and backrest lend the four-leg chair the appeal of high-quality dining-room seating. Its ergonomic comfort and clever stacking capabilities also ensure practical functionality in meetings and conferences. The upholstered and covered backrest shell adapts elastically and the breathable cushioning integrated in the seat frame is exceptionally comfortable. The harmonious shape of the bottom of the chair means it can be stacked without any pressure points forming in the seat. Whether with or without armrests, with a higher or athletically compact backrest – Ceno is a versatile four-leg chair in a class of its own.



341/7
 Want to put Chassis on the patio? No problem. A special dipping method to coat the frame makes the outdoor versions weather-proof.



341/1
 Multipurpose chair



341/5
 Multipurpose chair



341/6
 Multipurpose chair





Model 341/1

Chassis

340 range, design: Stefan Diez

A unique production method, fluid form and distinctive range of design options make this chair a strong presence in all sorts of places.

Crisp but still organic, contoured but still lightweight, technically precise, but still natural. The special shape, comfort and robust materials predestine the design icon for cafeterias and dining rooms, meeting and workshop spaces, recreational areas and studios. Its name says it all. Because just like vehicle bodies, the sheet-steel seat and backrest frame are made in one piece using a deep-drawing process. The tubular steel legs are welded by robot. A form-fit solution allows the seat shell to be clipped on. In addition to the basic uniform black, gray or white models, lots of frame colors and shell covers provide an enormous range of design options.



186/3
Cantilever chair



186/3
Cantilever chair



186/3
Cantilever chair



186/3
Cantilever chair,
up to 6 are stackable



reddot award 2017
winner



Focus Open 2017
Silver





Metrik

186 range, design: whiteID

Seminal, attractively priced version of the classic cantilever chair with an integrated, sculptural form, superior comfort and a range of design options.

The Metrik chair stands apart for its award-winning form whose different thickness of materials, polygonal areas and rounded edges are reminiscent of modern transportation design. The spacious shape of the inside of the chair with its integrated seat cushioning offers ergonomic comfort, which can be further enhanced by extra cushioning at the rear. New technologies allow production of such a complex seat from one piece of material at an affordable price. With its color-matched seat and frame, the chair has a seamless look. Six colors for the shells and frame and a variety of different seat covers allow lots of design options.



Model 186/3



The distinct design and the range of colors mean that Metrik can be seamlessly incorporated into a diverse range of design worlds. And a bright or black chrome-plated frame allows free-standing stacking of up to five.







221/10
Multipurpose chair,
not upholstered



221/22
Multipurpose chair,
with padding on the inside



221/30
Visitor chair
with felt cushion



221/30
Visitor chair,
not upholstered



222/10
Multipurpose chair,
not upholstered,
stackable



222/21
Multipurpose chair,
with seat cushioning



222/32
Visitor chair,
with padding on the inside



222/40
Task chair,
not upholstered



222/11
Multipurpose chair,
with seat cushioning,
up to 6 are stackable



222/32
Multipurpose chair,
not upholstered,
up to 10 are stackable



223/11
Bar stool,
with seat cushioning,
up to 8 are stackable



223/21
Bar stool,
not upholstered

→ **Occo tables**, page 127



reddot award 2017
winner

Not all awards apply to all types.



Models 222/31, 222/32 and 221/22

Occo chairs

222 range, design: jehs+laub

Despite the vast choice of 192 models, there's still a consistent design language. The range covers a four-leg chair that wouldn't look out of place in homes to task chairs and chairs that can be stacked in all contemporary meeting spaces.

Occo's strength is its diverse range of models with a consistent design language for a variety of settings. One shell shape with and without armrests (SC), four frames, four upholstery types and six shell colors produce 192 models. As a result, the chair responds to almost all function and design requirements – whether it's used in cafeterias, informal meeting areas, co-working spaces or meeting rooms requiring a little more gravitas. The characteristic seat and backrest shells are the design's common denominators. The shape of the cut-out section at the back and the different material thicknesses also ensure exceptional comfort. With the four-leg chrome-plated metal frame, up to ten of them can even be stacked on top of one another.





Model 222/40 with felt cushion



240/3
Cantilever chair,
low backrest



241/3
Cantilever chair,
medium-height backrest



241/3
Cantilever chair,
medium-height backrest,
up to 7 are stackable



241/51
Cantilever chair,
medium-height backrest



244/55
Cantilever chair,
medium-height backrest



245/55
Cantilever chair,
high backrest



247/55
Cantilever chair,
medium-height backrest



248/55
Cantilever chair,
high backrest

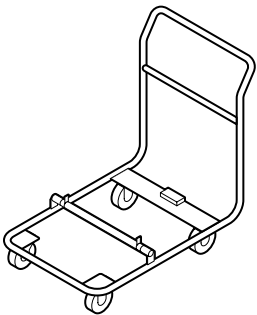

243
Four-wheeled trolley
for 8 stackable cantilever
chairs



Model 240/3

Sito

240 range, design: wiege

A fascinating structure, sprung comfort and an exciting design make this chair ideal for seminars or meetings, conferences or clubs.

The ingenious structure, consisting of tubular steel frame, delicate brace and self-supporting seat, ensures the cantilever chair range offers low material thicknesses and superior sprung comfort. The stackable variants have subtle protrusions in the support braces. Three backrest heights and four upholstery types (flat and fully upholstered, club upholstery and soft fill cushions) make the chairs ideal for seminars, meetings, company restaurants or conferences requiring a certain gravitas. Consequently, the seat and backrest are made of through-dyed plastic or molded plywood shells, the armrest pads are plastic, wood or upholstered and the covers range from hard-wearing textiles to sophisticated fabrics to fine leather. Whether the models are functional, athletic with a certain prestige, luxurious and relaxed, or wouldn't look out of place in homes, all offer a distinctive look and outstanding comfort.







860/2
Side table
65 x 65 cm, 120 x 60 cm
and 120 x 120 cm,
Height 40 cm



861/6
Upholstered chair
Widths 70 and 78 cm



862/5
Upholstered bench with backrest
Width 150 cm



863/5
Upholstered bench with backrest
Width 218 cm



865/3
Bench without backrest
Widths 144 and 215 cm





Models 861/6, 863/5 and 860/2

Asienta

860 range, design: jehs+laub

The last word in aesthetics, comfort and superlative quality. This lightweight chair with its stylish contours also comes with attractive upholstery and covers.

The delicate aluminum frame is lightweight and creates elegant contours that appear to be encased by the upholstery. The upholstery seamlessly envelops the cube-like shape on the outside. On the inside, its plump but streamlined look is eye-catching. They look soft yet come with firm upholstery, and the standalone chairs, two-seater and three-seater sofas, and upholstered benches with backrests stand apart for their excellent comfort. The secret lies in an exclusive upholstery technique of multiplex frames with wave springs, padded cut foam and precisely hand-sewn covers made of exquisite fabrics and leathers. The tops of the matching side tables, which are inserted into the aluminum frame, are made of veneered composite wood or glass that is varnished on the bottom.



249/5
Cantilever chairs



249/5
Cantilever chairs



249/7
Chairs



249/8
Stools



249/1
Side table
54 x 54 cm, 150 x 60 cm,
Height 36 cm



Model 249/5

Cura

249 range, design: wiege

An outstanding lounge chair that comes in a slimline shape but offers plenty of space to sit on. A distinctive chair with an athletic appeal that's still high quality.

The special frame structure and clear and subtly curved form of the upholstery make the cantilever chair stand out. The flat-steel strips with their distinctive connecting elements at the back of the tubular sections envelop and support the fully upholstered seat, which comes across as a crisp architectural shape thanks to the facings all the way around and the right-angled corners. Cura's steel frame has wave springs and is fully padded and covered, making it just as comfortable as an upholstered chair despite its compact size. A model with column, footstool and rectangular or square side tables round off the range.

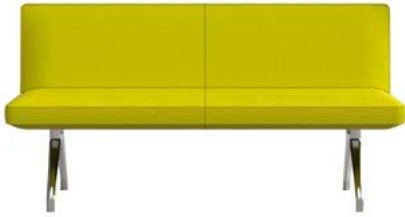

782/5
2-seater, linear backrest

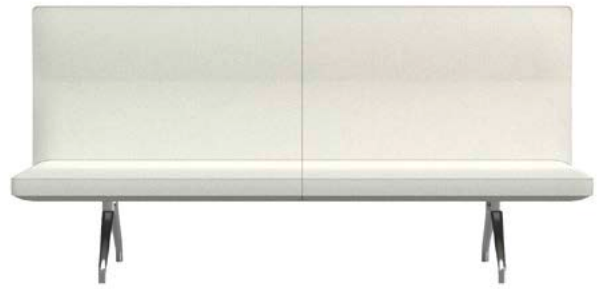

783/5
3-seater, high linear backrest

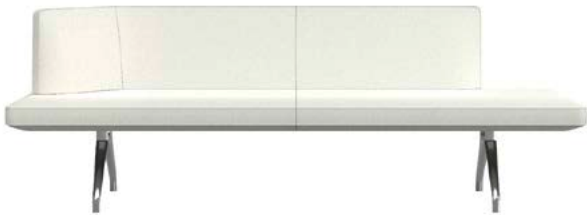

783/52
3-seater, backrest slopes to the right with open end on the left



783/56
2 x 1.5-seater, backrest that changes direction



782/90
Corner element, 2.5 x 2.5-seater, backrest at a 90° angle



783/6
3-seater bench without backrest



reddot award 2019
winner



Models 783/5 with customized radial element

Insit

780 range, design: Wolfgang C.R. Mezger

This is an attractive seating unit for working or chilling out on in lounges, areas in the middle of rooms, co-working spaces, or restaurants.

The design of contemporary offices needs to convey a distinct corporate identity, foster collaboration and instill a feeling of well-being. All three aspects were the inspiration for the Insit upholstered furniture range. Whether as a standalone piece or linked to form a sectional group – the characteristic design with its stylishly modeled frame, flat upholstery and distinctive backrest positioned on top is a symbol of collaborative working with a feel-good flair. Insit looks as if it's floating on air with firm upholstery to guarantee agile comfort. At a seating height of 45 cm, it enables people to hold discussions, work, or eat and drink at standard table heights. This makes Insit an attractive, eye-catching multipurpose item of furniture and is a place for office workers to sit, interact and collaborate.



The range includes benches without backrests, two-, two-and-a-half and three-seaters, which come with backrests that are linear, on one or both sides or at an angle for people to sit in opposite directions. Radial elements, corner benches and models with high backrests, power supply modules, connecting leaves and a coordinated choice of tables round off the range.





208/1
Flat element
60 x 60 cm, depth 5 cm



208/2
Relief element with shelf/
table
60 x 60 cm, depth 23 cm



208/2
Projecting element
60 x 60 cm, depth 23 cm

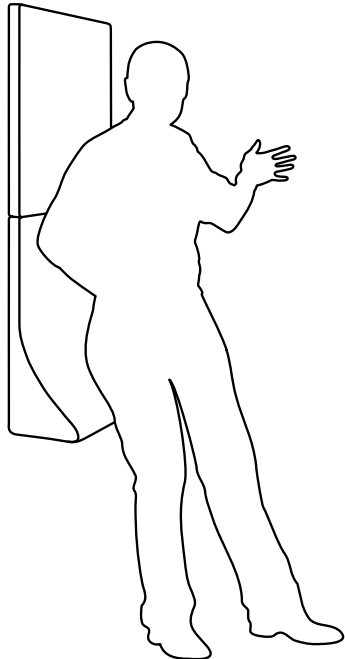
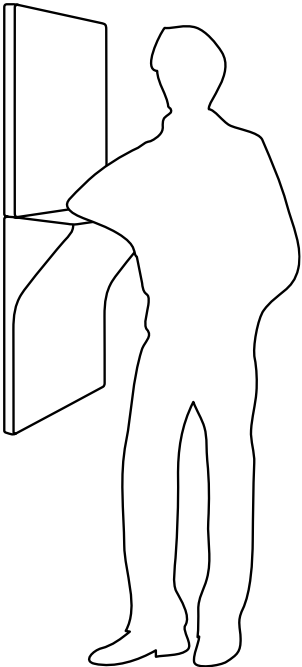



Landing

208 range, design: Rudolph Schelling Webermann

Landing encourages people to stop and chat wherever they happen to be. What's more, it's sound absorbent, attractive, simple and ingeniously versatile.

When planning office space, one of the most important tasks is to nurture interaction between people. The innovative, sound-absorbent wall relief modules create a welcoming atmosphere for spontaneous "stopovers," even in places where space is lacking such as aisles, cross-over spaces and stairwells. A flat, upholstered, textile-covered element, 60 x 60 cm in size, and an equally large three-dimensional relief component can be positioned and combined at will. Depending on its configuration, the relief can be used for perching or leaning on, as shelving or a screen for more privacy. Landing is available in seven colors, improves acoustics, creates niches, takes the weight off feet while standing and is a space for drinks and smartphones.



204/01
Black Sitzbock



204/02
White Sitzbock



204/03
Gray Sitzbock



204/04
Orange-red Sitzbock



204/01
Sitzbock with saddle
blanket

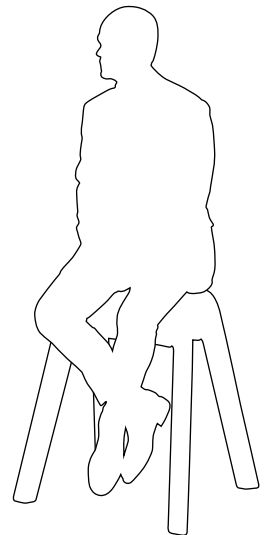
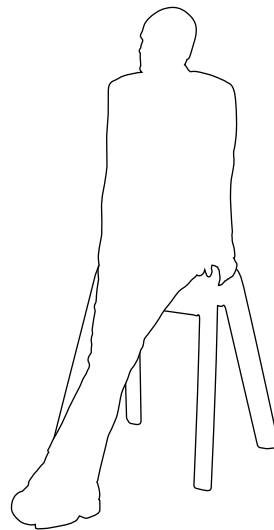
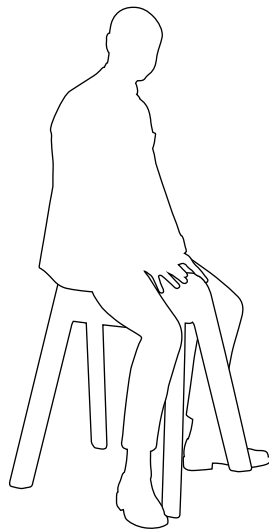

**INNOVATIONSPREIS
ARCHITEKTUR +
OFFICE**

2018



Sitzbock

204 range, design: Rudolph Schelling Webermann

The Sitzbock pommel horse seat is a refreshing way of gaining a new perspective and changing posture. It cultivates openness and creativity in workshops, office kitchen spaces or on outdoor patios.

When people chat to one another in kitchens, lobbies, corridors or recreational areas, it's a source of inspiration, innovation and change. Facilitating a change of perspective that looks beyond job roles and hierarchies requires refreshing design ideas like the Sitzbock pommel horse seat, which inspires both the body and the mind to try something different. You can sit astride, ride "side saddle" or use it to lean on. Made from through-dyed polypropylene in four colors and weighing just 4.8 kg, the seats are easy to place in groups, stack crosswise or pick up and take outside for a while. Anyone preferring a little more comfort can add a non-slip felt "saddle blanket" to their Sitzbock.



202/0104



**INNOVATIONSPREIS
ARCHITEKTUR +
OFFICE**





Stand-up

202 range, design: Thorsten Franck

A cheerful eye-catcher in nine colors to inspire people to take energetic breaks, indulge in a spot of contemplation or prevent back pain – and engage with each other in a fun new way.

Nowadays, instead of inactivity office breaks are all about activity and reflection so that body and mind recover. Stand-up does both perched on diagonally, it turns into a dynamic three-legged object that allows people to move their hips and give free rein to their imagination. It strengthens joints and muscles, improves balance and fosters contemplation and creativity. Anyone walking past this eye-catcher can't help but try it out. Even from an up to 50° angle, after a gentle push it swings back and rights itself again. The conical shape with its upholstered seat is fully covered in colored, three-dimensional fabric and the black plastic base won't slip. Whether positioned somewhere at an angle or in a group – Stand-up is the epitome of a fun approach to the serious side of (working) life.



201/1



201/2

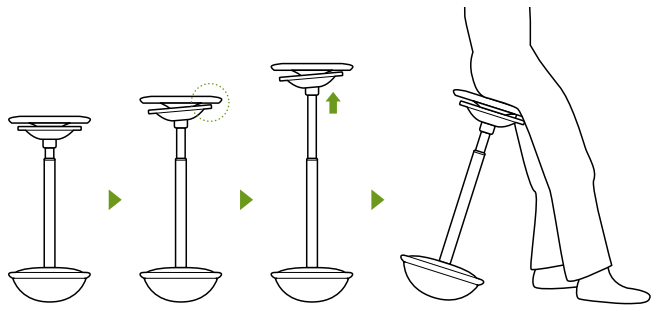

Design Preis Schweiz
Prix Design Suisse
Design Prize Switzerland

design
preis
SCHWEIZ



Stitz 2

20 range, design: ProduktEntwicklung Roericht

You're not meant to sit or perch on it but adopt a healthy posture somewhere in-between – an object that promotes movement and is as fresh and youthful as on day one.

Ingeniously reduced to the max, this design classic has always been ideal for people working in offices, studios, doctors' offices or holding presentations at lecterns – long before alternating between sitting and standing became popular. The seat frame and base cover's black, through-dyed, high-performance plastic is very hard-wearing. The intuitive height adjustment via a gas lift and grip all the way round makes this three-legged item (two of the legs belong to the user!) flexible to adjust depending on the height of the person and the angle it's perched on. The non-slip elastomer base filled with quartz sand ensures it can't slip – even at a tilt. The replaceable seat made of waxed cork is optionally available with a leather or fabric cover.



441/1
Mobile desk
Foldable, height 73 cm



448/9
Lectern
Height 106/115 cm



446/3
Server for catering/
presentation purposes
Height 96/107 cm



442/1
Flipchart
Height 180/200 cm



443/1
Pinboard/whiteboard
Nest into one another, height 190 cm



440/00
Folding table



Not all awards apply to all types.



Model 440/2

Confair and Confair folding table

440 range, design: wiege, Fritz Frenkler, Justus Kolberg, folding table: Andreas Störiko

An attractive table for maximum flexibility and efficiency in project offices, conference spaces or executive boardrooms.

Confair is all about encouraging people to engage actively with processes of innovation and change. The folding table is the star of the range and, even a quarter of century on, is still unrivaled in terms of functionality, quality and aesthetics. No tools are required and a spring-loaded mechanism makes it child's play to fold up, roll into another room and reassemble. And it can be moved from story to story because it fits in any elevator. The table's excellent design, power solutions and variety of formats and surfaces guarantee agility in both project spaces and executive boardrooms.







610/00



612/00 Timetable Smart



614/00 Timetable Shift



615/00 Timetable Lift

Goes with
→ **Confair folding table**, page 103
→ **Logon**, page 125



Design Center
Stuttgart

Not all awards apply to all types.



Model 614/00

Timetable

610 range, design: Andreas Störiko

These tables offer first-class design and a touch of sophistication. What's more, they foster a team spirit among seminar or conference attendees or project teams because the participants can organize the way a space is set up.

Timetable's table tops flip up in one easy step and the foot sections turn inward in the process. As a result, they're easy to move from room to room and nest very compactly into one another. Intuitive handling, exceptional quality and a strong aesthetic inspire a change of methods and save resources, time and space. The exceptionally hard-wearing Timetable Smart with its power solutions has uncovered further usage potential and found its way into hot desking, training and project spaces. The frame design of its big brother (Timetable Shift) means it can be combined perfectly with Confair folding tables and Logon tables. The U-shaped aluminum profile to help connect the legs also provides a spacious cable channel at the same time. Timetable comes in lots of different formats, shapes, lipping and surfaces.



Model 610/00



Model 615/10



Timetable Lift takes flexibility into a third dimension. Its height can be electrically adjusted up to 139 cm, making it ideal for hot desking or as a scalable seminar, project, conference and presentation table in areas where alternate sitting-standing postures are encouraged. The superbly designed tables are compact to stow away, wheel in as required are easy to set up in one step, and adjust to the right height at the touch of a button. Battery operation makes the tables independent of a power supply so they can be moved anywhere. And what's more, you can write on the table top and flip it up to become a mobile projection screen and whiteboard.



Accessories

Table-table-connectors, modesty panel, four-wheeled trolley



Models 540/15 with 541/15 connecting leaf





Contas

540 range, design: wiege, Fritz Frenkler, Anette Ponholzer

The stylish folding table system with four feet is an attractive addition to seminar and conference spaces.

The versatile table system offers a classic shape, ease of use, and high-quality materials and surfaces that are ideal for modern conference areas or seminar and training spaces. Because the simple, clear form featuring frame profiles integrated flush with the table top and rounded table-leg connectors is a clever solution. Thanks to the flip-out panel connector, the stand-alone and folding tables can be linked with connecting leaves in no time and table configurations adapted to suit the number of people, methods and rooms. This all-rounder is available in a choice of surfaces and comes with ingenious features such as an integrated separator, table-leg mounts, locking mechanisms and clever accessories to help cut facility management costs.



460/00
System table, 150 x 70 cm
for linkage on both sides, soft matte laminate with straight
wood lipping



462/00
Standalone table, 180 x 80 cm
Soft matte laminate with straight wood lipping.



462/00
Standalone table, 220 x 80 cm
Soft matte laminate,
bullnose double with integral, impact-resilient profile.



reddot award 2018
winner



Models 460/00 with 461/00 connecting leaves

mAx and mAx light

460 and 465 range, design: Andreas Störiko

These items are champions among tables with T-shaped bases because they can be set up with one hand, have self-stabilizing capabilities, integrated linkage fittings and are the last word in system diversity.

In terms of variety, clever handling options and aesthetics, mAx sets new standards. The material and craftsmanship of the die-cast aluminum legs with their patented folding mechanism don't just guarantee stability and durability, but also have a look of superb quality. Three different table foot sizes enable a range of different shapes and table depths for all sorts of usages, from loosely arranged groups to rows of tables linked linearly and open or closed conference table configurations. The mAx light 465 models with their rigid and lightweight table tops are ideal for spaces that are constantly rearranged. The array of surfaces available also responds to virtually any design requirements. Whether destined for meeting rooms, versatile conference and seminar centers, project and group-work areas, co-working spaces or versatile restaurants and cafés – mAx really does check all the boxes wherever it is.



640/00
Rectangular



The simple connection between the rigid table tops and the table legs is a highlight. You just release the bayonet lock, lift the table top up, move the table leg, add the next table top and engage the bayonet lock again.

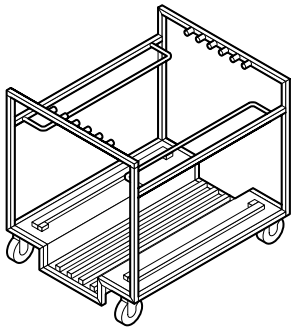

646/01



Design Preis Schweiz
Prix Design Suisse
Design Prize Switzerland

**design
preis
SCHWEIZ**



Model 640/00 with 641 table leg

Palette

640 range, design: Karlheinz Rubner

This superior-quality, traditionally designed range for versatile executive board rooms and conference spaces looks inalterable but can actually be changed at any time.

It's the pared-down look achieved by the solid, straight table top resting on four column-like table legs that makes Palette stand apart from virtually any other table range. But the range has even more to offer because the leg can be released and repositioned in just one easy step to accommodate an additional table top. As a result, table systems are created, extended or divided up to suit the purpose at hand. The rigid table tops covered in veneers or laminates don't require any underframes. This creates more leg room, and table tops not currently in use are space-saving to stow away. Just one single rectangular table top and table leg type can produce an almost endless variety of combinations. From a stand-alone table to a desk for two to a conference system of any size, with a variety of formats to suit any room – whatever its shape. Customized power solutions are also possible on request.



638/00





Models 636/51 and 636/52

Versa

636 range, design: Wolfgang.C.R. Mezger

This lightweight and versatile conference table range for today's conferences and executive boardrooms is easy to adapt and comes with plenty of design options.

The molded form of the elegantly stylish aluminum frame, which appears to have been made from a single piece of material, underscores the classy look of the configurations. The bayonet lock on the frame and table top connection allows tables to be set up, extended, made smaller or dismantled again in no time. Lots of different shapes and formats offer the right solutions for any size of room, number of attendees and type of conference. What's more, they come with surfaces and in colors to match the space in question.



236/1
Round Ø 75 cm
Square 60 x 60 cm
Height 45 cm



235/2
Square 70 x 70 cm
Round Ø 75 cm
Height 73 cm



235/3
Square 60 x 60 cm
Height 105 cm



236/3
Round Ø 70 cm
Height 105 cm
Optionally nest into one another



237/00
Rectangular
Depth 70 – 90 cm
Width 140 – 200 cm
Height 73 cm



237/6
Round
Ø 90 – 140 cm
Height 73 cm

→ **Aline chairs**, page 63



Aline tables

230 range, design: Andreas Störiko

Refined elegance with style to spare for home offices, foyers, recreational or cafeteria spaces, showrooms or dining tables at home.

The subtle appeal of the comprehensive Aline table family is ideal for furnishing those in-between spaces that need to look both informal and professional. The chamfered, practical table tops on the round and square column tables at low, sitting or standing heights and the twin-column rectangular tables are made of hard-wearing, through-dyed HPL (high pressure laminate) just 12 mm thick. The slots in the table top allowing up to three high tables to nest into one another are particularly innovative features. The aluminum star bases and foot sections, the tubular steel table columns and the steel disc base on the large round tables (in this case the table top is made of medium density fiberboard 25 mm thick) are hard-wearing and attractive.



600/00

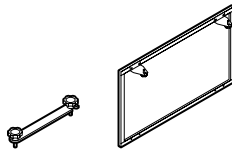

Accessories

Table-table-connectors, modesty panel





Model 600/00

Conversa

600 range, design: wiege

A multipurpose four-leg table with a distinctive frame for scalable rectangular shapes up to conference tables measuring 160 x 160 cm for eight people.

This four-leg table features retractable underframes and a space between the table top and table leg. It also comes in a wide range of formats, making it ideal for office, seminar, conference and canteen spaces all the way to executive boardrooms. It owes this versatility to a modular system of steel underframes, corner knuckles, steel legs and table tops. Refined joints, attractive table-leg mounts and table tops that appear to float on air define the impeccable design throughout. A selection of frame- and table-surfaces offers a wide range of design options.



300

→ Graph chairs, page 51

122



2014



Winner



WINNER 2015



Graph tables

300 range, design: jehs+laub



These tables are a design statement for contemporary conference spaces and executive board rooms and have large table tops, few legs and a consistent design language.

Just like the Graph chairs, the exclusive table range is defined by the consummate fusion of edges and fluid lines, surfaces and curved sections. The sleek lines of the sloping table legs continue seamlessly in the aluminum underframes and even make multi-component frames look like a single unit. The table tops appear to float on air because they taper toward the edges and protrude over the legs. The formats comprise round tables with just four legs for up to 12 people, rounded square tables, and long or compact oval configurations for up to 22 people. The formats are versatile with MDF table tops and table frames that adapt precisely to a wide range of interiors.



620/00
Rectangular

Goes with:
→ **Confair folding table**, page 103, → **Timetable Shift**, page 107



Logon

620 range, design: Andreas Störko

These tables with their twin tubing and impact-resilient profiles are top choices for table systems in a consistent language – whether they stand alone, are linked together or combined with mobile friends.

Logon tables are an excellent option when an open and dynamic approach paired with top quality and hard-wearing elegance are the order of the day. The rounded laminated wood edges with their integrated impact-resilient profiles, slender uprights and stylishly modeled foot sections lend stand-alone tables and table systems light-as-a-feather simplicity. The look is achieved thanks to a smart tensile structure in the frame that originated in aircraft construction. Whether as a stand-alone table or linked table system, on height-adjustable glides, or for portable use on casters – Logon is the perfect answer to any requirements. Combined with the Confair folding table and Timetable Shift, seamless solutions are produced even in multipurpose settings.



222/90
Oval

→ **Occo chairs**, page 79



Model 292/90

Occo tables

222 range, design: jehs+laub

The lightweight and classy table range for those occasions when informal meet-ups are needed encourages people to interact and is perfectly coordinated with the conference chairs.

Occo tables are the ideal choice for interior designers and architects seeking the perfect furniture for design concepts, where a clear design language is required despite all the versatile uses. Because in terms of form and function, the table range matches the Occo chair models perfectly and is at home in cafeterias, customer service areas, meeting spaces or club rooms. The tubular steel table frame with optional swivel casters echoes the contours of the star base. The square, rectangular, round and oval formats reflect the blend of organic shape and clear-cut geometries. The table tops come with direct coating, veneers, high pressure laminate (HPL), or solid oak. This is a case of design reflecting contemporary styles of working.



661/41

Travis

90 x 180 cm, 100 x 200 cm or 80/120 x 230 cm, height 71–118 cm

Changing posture while working at desks or attending meetings is a good idea, so Travis comes as a twin-column stand-alone table with electrical height adjustment. So any sit-down meeting can spontaneously be turned into a standing-up one.



reddot design award
winner 2008



Travis

661 range, design: wiege

Whether used as desks or communicative conference tables, Travis keeps body and mind fit because it encourages people to alternate between sitting and standing.

Ranging from a seating height of 71 cm to a standing height of 118 cm, the Travis tables can be adjusted to the right height at the touch of a button. The sturdy steel frame with its T-shaped feet and telescopic lifting columns make the furniture stable even when it comes as a conference table in a barrel-shaped format, 230 x 100 cm in size. Three formats and a wide choice of table tops and frame surfaces mean that the furniture can be used as a desk, for executive board rooms or as a conference table for eight people. Design at work – quite literally.

Built-in component sets



Integrated techni-station Basic



Integrated techni-station Rotate



Single table portal Executive



Single table portal Basic





Integrated techni-station Compact



Socket strips

Graph single table portal



Integrated techni-station Move

Techni-station Compact Add

For integration of techni-stations into the different table models, please see the price list.

Environmental information

Wilkhahn and sustainability

In over 100 years of its corporate history, Wilkhahn can look back on a sustainability philosophy that has grown over decades. Aspects such as durability, social fairness, environmental responsibility and cultural orientation have been evolving as corporate principles since the 1950s. Wilkhahn today is regarded internationally as a model of excellence, not only on account of its products but also because of its modern corporate philosophy. This is because the company realized early on that sustainable design should embrace environmental aspects, improve social relationships and define the cultural role of a company. This approach to the way we do business creates a bond between us and our customers throughout the world. There is surely no more rewarding task than working together for a successful future that is worth living in.

Corporate principles

Honest product design

We strive to develop durable products, increase their utility value and reduce waste. "Less is more" or "reduce to the max" are principles that Wilkhahn constantly reinterprets for the future. Ecologically driven design principles are a natural, integral part of product development at Wilkhahn.

A spirit of fairness

Wilkhahn applies a spirit of fairness toward its employees, partners and customers. This means providing first-class analyses, information, advice, management and support. In the company itself we embrace a collaborative management style which sees employee representatives as co-managers who help shape the company. Fairness and continuous improvement of working conditions also apply to our supply chains. To achieve these aims Wilkhahn has signed an international agreement on fostering employee rights.

Ecological responsibility

Wilkhahn supports sustainable development. The balance we seek to strike between financial, ecological, social and cultural objectives in order to maintain independence defines Wilkhahn's corporate culture. Compliance with ecological quality criteria throughout the product life cycle is one of the ways we gauge our own success.

Employees as partners

Top performance requires a potential-driven style to the way we organize our company, with flexible working hours, a bonus plan, and group and project work. In turn, all employees share in corporate success in material terms. They enjoy a comprehensive retirement plan and an employee-focused health program. And thanks to pioneering measures regarding the architecture of their surroundings, they work in an environment that reconciles social, ecological, economic and aesthetic requirements.

Sustainability policy



UN Global Compact

Wilkhahn joined the United Nations Global Compact in 2007. The company has committed to the ten principles of Global Compact regarding the protection of international human rights, adherence to labor standards and rights for employees, the protection of the environment and anti-corruption, all of which are specified as binding corporate policy.



ISO 9001 quality management system

In order to safeguard and continuously optimize the high quality of products and processes, a comprehensive quality management system was set up in 1996. Since then it has been certified for compliance with the ISO 9001 quality management standard of the International Standardization Organization. Quality management is all about customer focus, management responsibility, the participation of all employees ensuring and improving process safety, and supplier relations.

ISO 14001 environmental management system

In addition, Wilkhahn is certified in accordance with the international ISO 14001 environmental management standard. This is the standard which sets out internationally recognized specifications for an environmental management system, such as reducing ecological footprints and evaluating environmental data and environmental performance.



EMAS

EMAS is the acronym for EcoManagement and Audit Scheme, developed by the European Union. As a combined environmental management and auditing system, its purpose is to verify companies are improving their environmental performance. At the north German headquarters in Bad Münde, Wilkhahn has been regularly certified based on the latest version of EMAS since 2001. In its environmental statement, confirmed by annual audits, Wilkhahn gives a public account of the company's environmental performance.

The printed version of the environmental statement can be ordered at www.wilkhahn.com/service. Detailed ecological product information on each of the products is also available to download.



FSC

The Forest Stewardship Council® (FSC) quality label indicates compliance with stringent socio-ecological requirements in terms of forest management and trading wood products. Wilkhahn's Bad Münde headquarters meet the criteria of the Forest Stewardship Council (FSC) and are entitled to process and sell FSC®-certified products (license code C118389, certificate no. TUEV-COC-000462).

Product certification

Wilkhahn office ranges are not only certified according to international testing and inspection standards regarding product safety and functional integrity. They also meet all key international reference systems for highly health-compatible and environmentally friendly products.



GREENGUARD™

Virtually all Wilkhahn ranges undergo GREENGUARD testing and certification. The Greenguard Environmental Institute is an independent institution in the United States that primarily certifies products with regard to their suitability for interiors. Besides environmental aspects, special focus is placed on ensuring that products do not emit any pollutants that might be harmful to health.



LEED

Leadership in Energy and Environmental Design (LEED) is a rating system used by the US Green Building Council to evaluate the environmental and social compatibility of buildings. LEED certification awards extra credit points if Wilkhahn office chair and table ranges are used.



Green Star

Green Star is an extensive, voluntary rating system developed by the Australian Green Building Council. The system assesses how

ecological a building's design is. The system uses various categories to rate any potential ecological impact resulting from a location chosen for a project and the way the project is carried out, managed or designed. Environmental Product Information sheets, as well as classifications regarding LEED and Green Star, are listed under the product ranges concerned and can be downloaded at www.wilkhahn.com.

Responsibility from the very start

In the design and development process, ecological impact is also taken into consideration in addition to design, functional and business-related aspects. Because these factors play a pivotal role in the materials chosen, manufacturing processes, options regarding assembly, logistics and transport and how easy products are to repair or recycle. This overview shows the key aspects for the entire product life cycle that currently apply at Wilkhahn.

Materials

The materials used are subject to stringent controls. Banned chemicals are not used in any of the products. All feedstock is listed in a register of hazardous substances. This helps to minimize the use of or substitute any potentially harmful materials. With the goal being to achieve maximum durability and quality, some recycled materials are used in the production of Wilkhahn ranges. This applies in particular to metals like steel and aluminum.

Production

Water conservation, waste management and sustainable energy production

Water is becoming an increasingly important resource. Wilkhahn spares no effort in minimizing water consumption in all areas. By treating process water, recycling and using state-of-the-art varnishing machinery, no waste water is produced that requires monitoring. The Wilkhahn waste management concept includes sorting waste selectively, as well as recycling and disposing of all waste fractions resulting from the production and management departments. The continual decrease of energy consumption is an important goal of the environmental management system. A combined heat and power plant and connection to a biogas plant at the Bad Münden site have more than doubled energy efficiency. As a result, heating at the headquarters and production facilities is CO₂ neutral.

Wilkhahn production sites

Wilkhahn products are manufactured or assembled in Bad Münden (Germany) and Sydney (Australia). The branch facilities and the international subsidiaries are not only subject to quality management requirements, but also to guidelines for the socio-ecological focus of corporate policy which apply through the entire company.

Product utility

Aesthetics and design

Sustainable products must be practical. Products are sustainable if they serve a purpose. The timeless design of the Wilkhahn ranges also means they are useful, intuitive to operate and the materials are durable. A standard that is reflected in every single detail. The Wilkhahn design approach therefore results in an increase in the utility value of a product that is destined to last.

Durability and guarantee

The ranges set standards for product design that is sustainable in the best possible sense of the word. The durability of the high-quality materials, the innovative functionality and the traditional, understated design guarantee our furniture will last for decades. We give a five-year manufacturers' guarantee, allowing customers to plan reliably (refer to the relevant guarantee policy for details). An issue we feel responsible for, regardless of our products' long service lives. We consider guarantees beyond these periods as selling the future short. Our services to extend the ecological life of the furniture include maintenance as well as an overhaul of older ranges. Wilkhahn guarantees it will carry out repairs on discontinued furniture for at least two years after production has ceased.

End of the product lifecycle

Product take-back and recycling

Even after the product has reached the end of its life, we still feel responsible and offer our customers extensive take-back and recycling services. We guarantee to take back all products that are no longer in use. Wilkhahn products are dismantled in the factory, all parts are sorted by material and then recycled if possible. By labeling the materials and ensuring they're non-toxic and easy to dismantle, we're already making sure today that the components in Wilkhahn products can be incorporated into local material and production cycles and properly recycled and disposed of.

Disassembly and recycling

Most of Wilkhahn's product components are suitable for non-destructive disassembly. To ensure that materials can be sorted according to type, all components weighing more than 150 g have been labeled accordingly. No agents to protect materials or organic halogen compounds are used which would prevent subsequent recycling.

Service

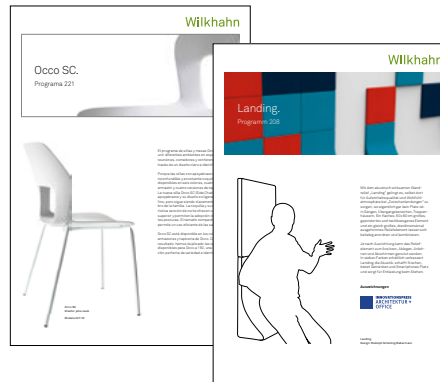
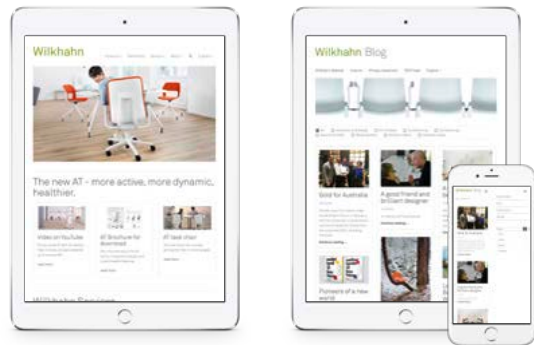

The website's new structure and design provide easy and clear access to Wilkhahn's products, projects and services. You'll be able to find everything you need there – from the digital brochure to CAD data and reference images.

Why not read our blog to find out all the exciting things happening at Wilkhahn in the world of design, architecture and industry?

The Wilkhahn app, powered by Architonic, is the perfect way of finding information fast.

Our online product literature and digital brochures contain more in-depth information.



Creative direction
Rainer Schilling

Design
scherrer.

Text
Burkhard Remmers

Photography
Armin Kammer, Löhne (pages 14, 15, 16, 17)
Axel Bleyer, Ohlsbach (pages 16, 103)
Fiona Susanto Photography (page 51)
Heinrich Hecht (pages 60/61)
Herbert Hirche (page 7)
Karl Huber Fotodesign, Nagold (pages 45)
Klemens Ortmeier (pages 5, 6)
Mandy Will, Wedemark (pages 6/7)
Penny Yan (pages 70/71)
Perlbach Fotodesign, Preetz (pages 64, 65)
Peter Teschner (page 89)
schumacher photo, Stuttgart (page 44)
Stijn Poelstra (pages 72/73)
Tom Wolf (pages 84/85)
Valerie Clarysse (page 30)
Werner Huthmacher (pages 124/125)
White ID (page 18)
Wilkhahn Archiv (pages 4/5, 8, 9, 10, 11, 12, 13, 14, 16)

All other images by photographers commissioned by Wilkhahn:
Espen Eichhöfer, Ostkreuz Agentur der Fotografen
Frank Schinski, Ostkreuz Agentur der Fotografen
Thomas Bach
Vojslav Nikolic

Project management and production
scherrer.

Languages
German, English, French, Spanish

© 2019 Wilkhahn
Wilkening + Hahne GmbH+Co. KG
Fritz-Hahne-Straße 8
31848 Bad Münder
Germany

Nominal charge EUR 14

Wilkhahn Germany

Wilkening + Hahne GmbH+Co. KG, Fritz-Hahne-Straße 8, 31848 Bad Münder

Wilkhahn worldwide

Australia, Belgium, China, Deutschland, España, France, Hong Kong, Japan, Maroc, Nederland, Österreich, Polska, Schweiz, Singapore, South Africa, United Arab Emirates, United Kingdom, United States of America

wilkhahn.com