

Wilkhahn

Versa





The extendable Versa table system is all about visionary conference and management styles. Here it is paired with the Intra conference chair (design: Phoenix). Model 637/51 with model 637/52, 107/120 cm x 400 cm (42 $\frac{1}{8}$ "/47 $\frac{1}{4}$ " x 157 $\frac{1}{2}$ "") with 8 x Intra chair model 295/7

# Versa

---

636 range, design: Wolfgang C.R. Mezger

---

Today's workspaces are geared towards communication, collaboration and flexibility. Thanks to its customizable design options and versatility, the sophisticated Versa table system reflects the requirements of contemporary office environments. At the heart of the range lie the stylish, seamless-looking, die-cast aluminum base frames. These are joined with bayonet connectors to the table tops, which come in various shapes and formats. As a result, stand-alone tables and table systems can be configured for almost any purpose and set up without tools in no time. Furthermore, by adding appropriate components, the table systems can be extended and reduced in size as required to adapt spaces to different numbers of people and settings.



---

## 638/00

Stand-alone tables

180 – 260 cm x 90 – 120 cm (70 $\frac{5}{8}$ " – 102 $\frac{3}{8}$ " x 35 $\frac{3}{8}$ " – 47 $\frac{1}{4}$ "),  
H 73 cm (28 $\frac{3}{4}$ " )



---

## 636/00

System tables

80 – 220 cm x 80 – 100 cm (31 $\frac{1}{2}$ " – 86 $\frac{5}{8}$ " x 31 $\frac{1}{2}$ " – 39 $\frac{3}{8}$ "),  
H 73 cm (28 $\frac{3}{4}$ " )



---

## 637/00

System tables

90 – 220 cm x 120 – 150 cm (35 $\frac{3}{8}$ " – 86 $\frac{5}{8}$ " x 47 $\frac{1}{4}$ " – 59"),  
H 73 cm (28 $\frac{3}{4}$ " )



Rectangular system components are ideal for multipurpose conference and seminar spaces that can be partitioned. The tables can be configured for seminars or corner elements create a conference setting that can be enlarged as desired. In the foreground: 4 x front panels, model 636/22, background: 2 x semi-trapezoid panels on the right, model 636/20, 2 x semi-trapezoid panels on the left, 636/21, 3 x rectangular models 636/00 with 21 Metrik cantilever chairs, model 186/3



First, the bayonet connectors attaching the base frame to the table top are released ...



... then the table top is lifted up, the base frame moved and locked in place again...



2 x semi-trapezoid panels on the right, model 636/20, 2 x semi-trapezoid panels on the left, model 636/21,  
2 x front panels, model 636/22, 6 x rectangular models 636/00 with 24 Metrik cantilever chairs, model 186/3



... so that another table top can be added and connected to the base frame.

Only one base frame is required at each linkage point. The narrow A-line form of the base frame at knee height allows plenty of leg room and saves material and costs.



The shape and surface of the base frame on the oval table system match the conference chair frames.  
Model 637/51 and model 637/52 with 6 x Intra chairs, model 295/6

Example configurations

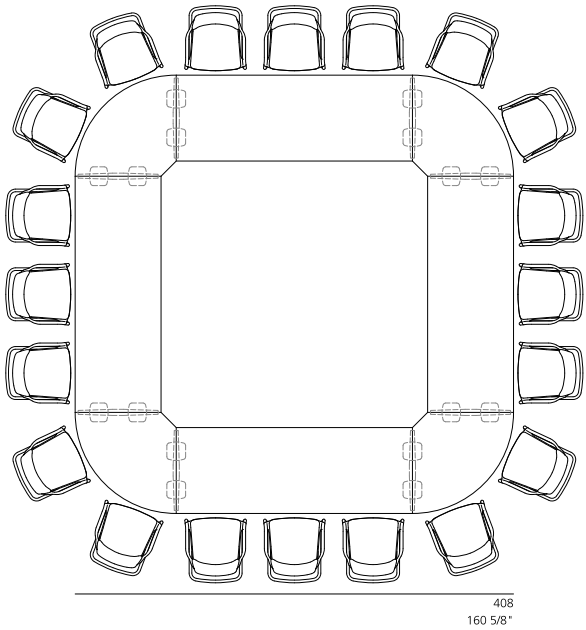

20 people  
4 x 636/00, 4 x 636/14

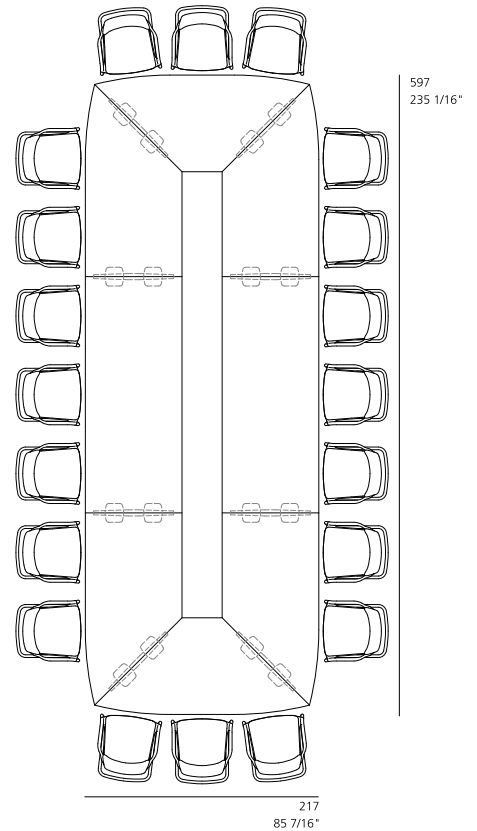

20 people  
2 x 636/00, 2 x 636/20  
2 x 636/21, 2 x 636/22

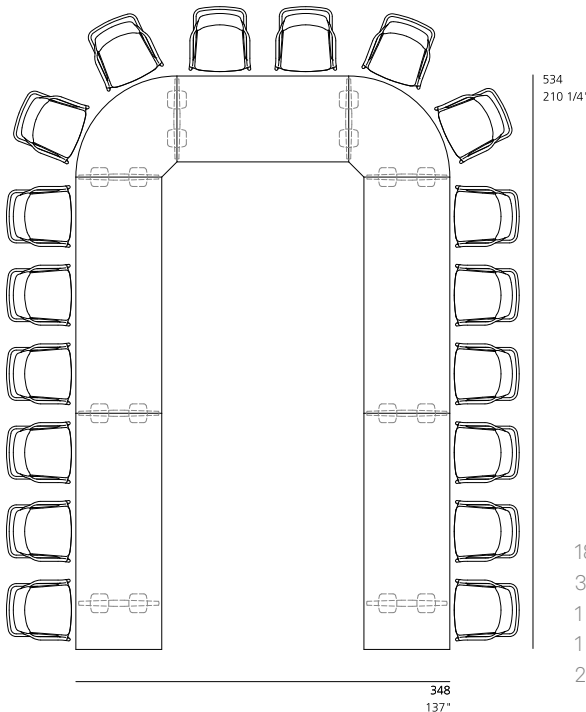

18 people  
3 x 636/00  
1 x 636/11  
1 x 636/12  
2 x 636/14

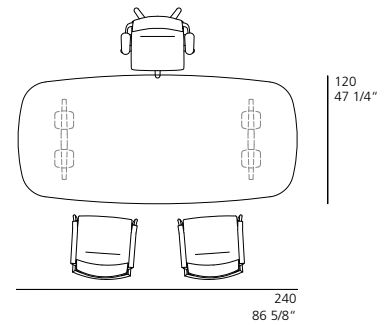

3 people  
638/51

All sizes in metric and imperial measurements.  
Subject to change.

Example configurations

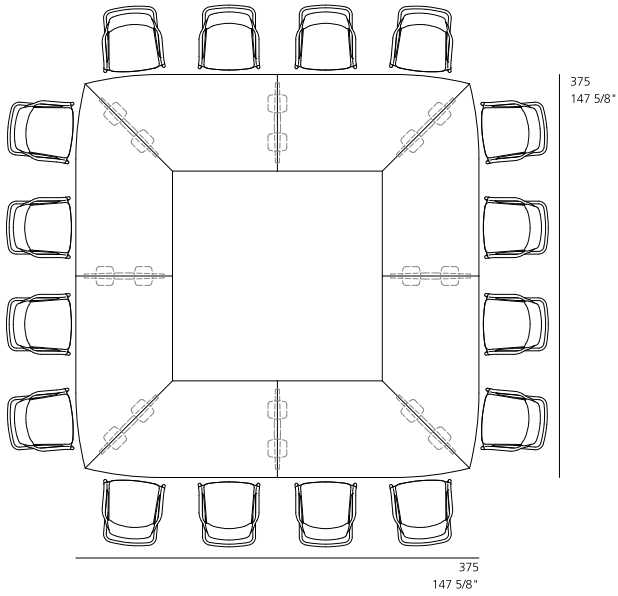

16 people  
4 x 636/20, 4 x 636/21

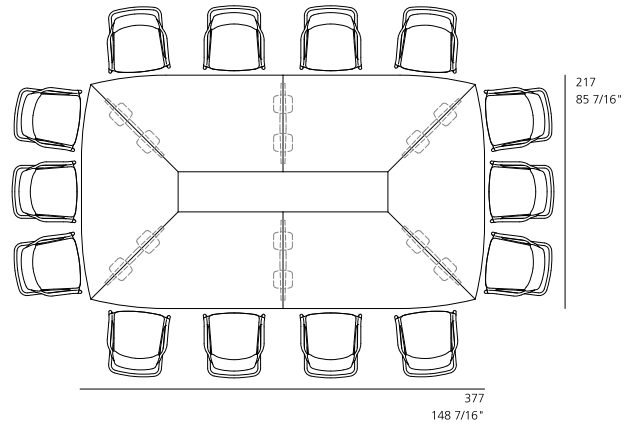

14 people  
2 x 636/20, 2 x 636/21, 2 x 636/22

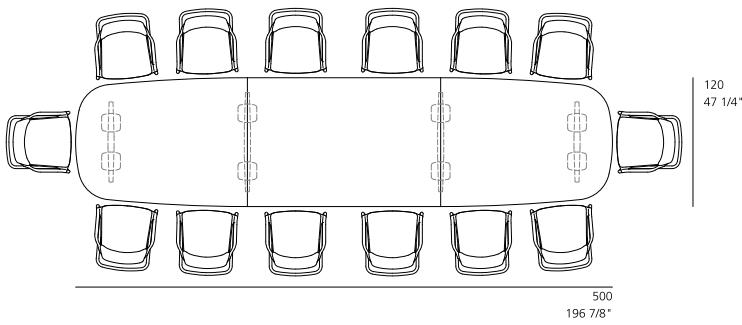

14 people  
1 x 637/51, 1 x 637/00, 1 x 637/52

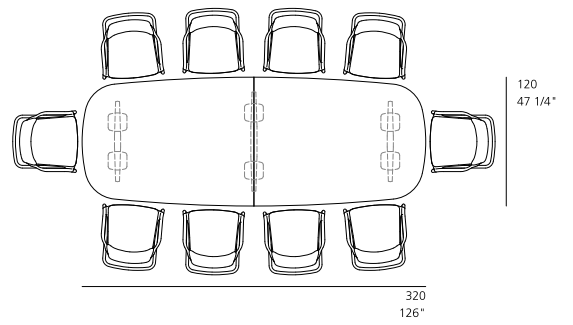

10 people  
1 x 637/51, 1 x 637/52



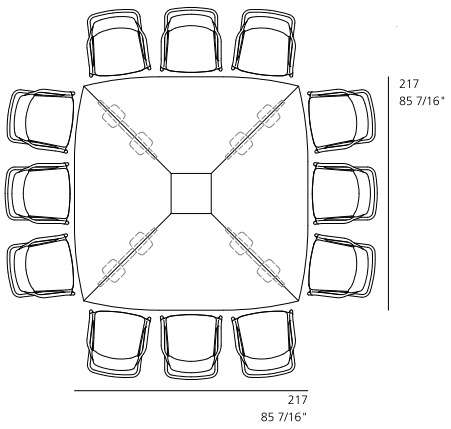

12 people  
4 x 636/22

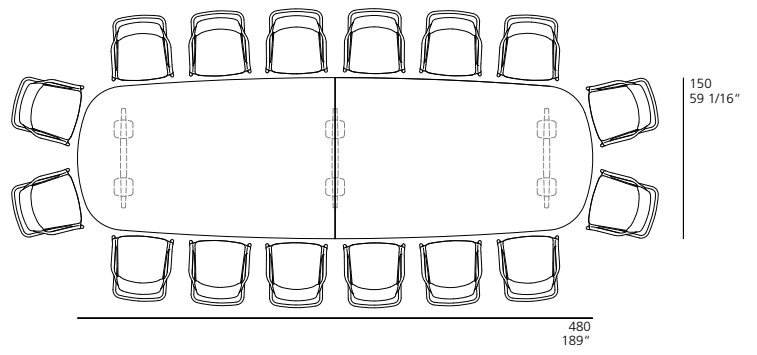

16 people  
1 x 637/51, 1 x 637/52

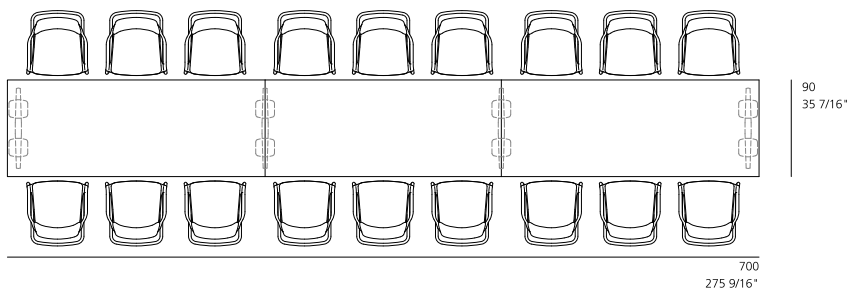

18 people  
3 x 636/00

All sizes in metric and imperial measurements.  
Subject to change.



The frame surfaces of the Versa table range and Intra chair range coordinate perfectly with one another to produce seamless solutions. Model 637/51 with model 637/52, 107/120 cm x 400 cm (42 $\frac{3}{8}$ "/47 $\frac{1}{4}$ " x 157 $\frac{1}{2}$ ") with 8 x Intra chairs, model 295/7

---

Accessories



Optional, black fabric modesty panels can be hung from the table tops.

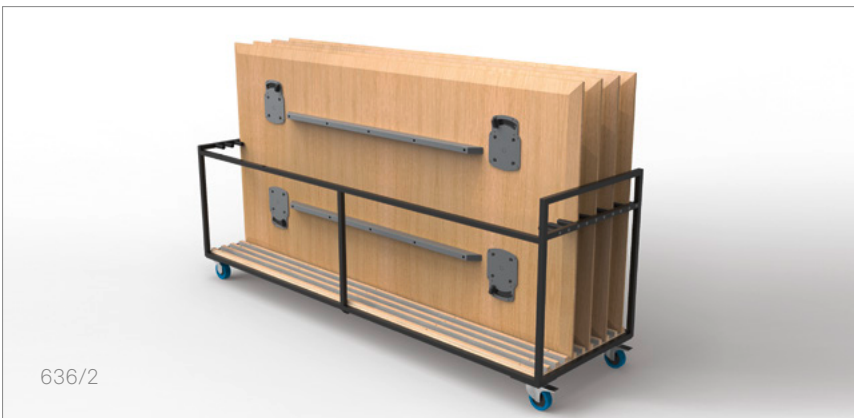

Any table tops and base frames not currently required can be stowed away on the corresponding four-wheeled trolleys.

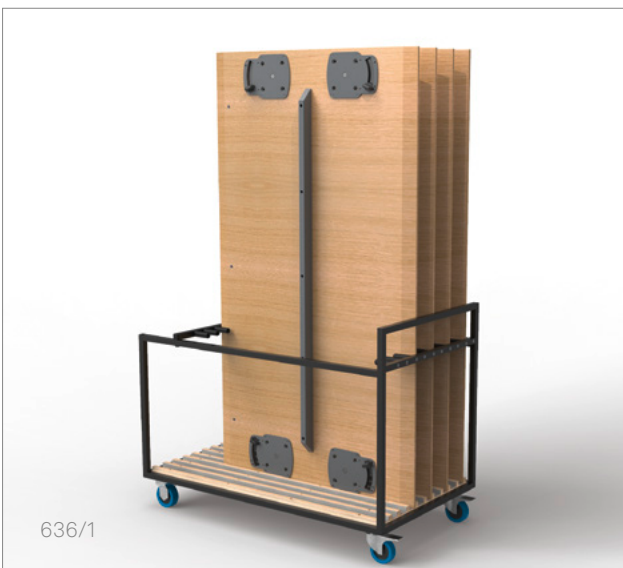

## Shapes and sizes

### Standardized table tops in 80, 90 and 100 cm (31½", 35⅝" and 39⅜") table depths

#### 636/11 and 636/12

Rectangular starter and end table top panels

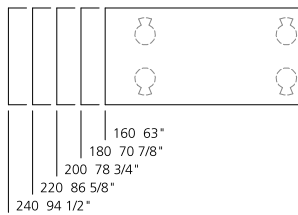

#### 636/00

Square and rectangular standardized system panels

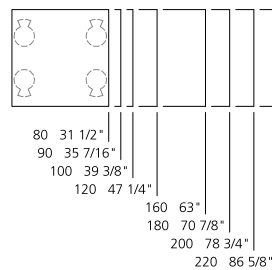

### Stand-alone tables in (35⅝", 39⅜" and 47¼") table depths

#### 638/00

Rectangular tables

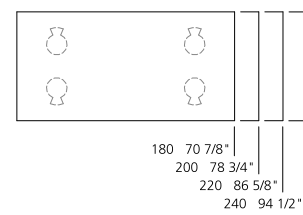

#### 636/20 and 636/21

45° semi-trapezoid table tops left and right

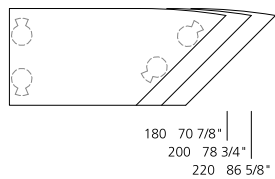

#### 636/22

90° front panel

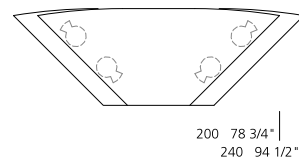

#### 638/51

Tables in a barrel shape

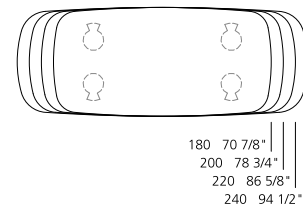

#### 636/14

Circular segment and 90° corner panel

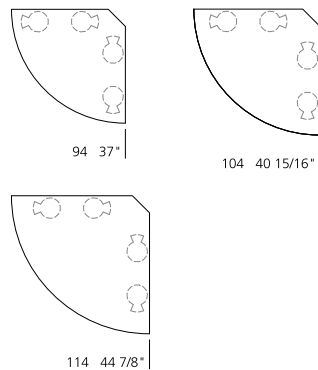

The range comes with rectangular and barrel-shaped stand-alone and versatile system tables to maximize the ways they can be used. Square, rectangular, semi-barrel-shaped, trapezoid, semi-trapezoid and 90° circular segment panels produce all sorts of configurations; table depths can be changed flexibly and panels combined with one another.

Table depths from 80 cm to 150 cm (31½" to 59") and table widths from 80 cm to 240 cm (31½" to 94½") enable solutions for any room size, number of people and conference type. Versa is an excellent choice for executive offices, conference and seminar spaces or project and meeting rooms that require a touch of prestige.

## Frame

A slender base frame is used for 80, 90 and 100 cm (31½", 35⅝" and 39⅜") and a wide one for 120 and 150 cm (47¼" and 59") table depths.

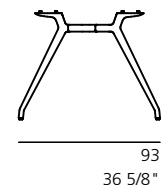
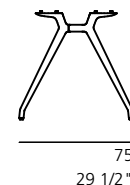
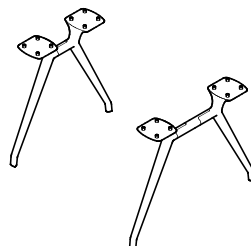

**Built-in component sets**

**Standardized table tops in 120 and 150 cm (47¼" and 59") table depths**

**637/11 and 637/12**

Rectangular starter and end table top panels

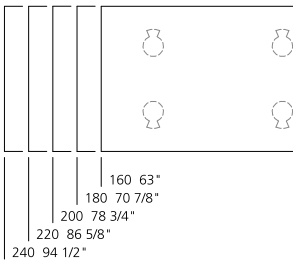

Integrated techni-station Compact with a wireless charging slot

**637/00**

Square and rectangular standardized system panels

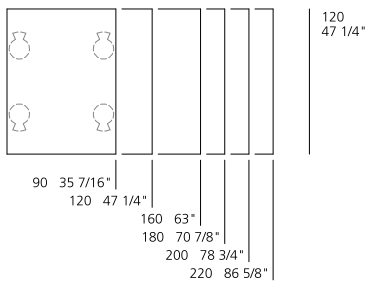

Single table portal Executive



**637/51 and 637/52**

Semi-barrel-shaped starter and end table top panels

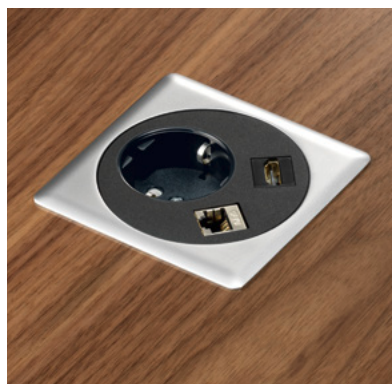
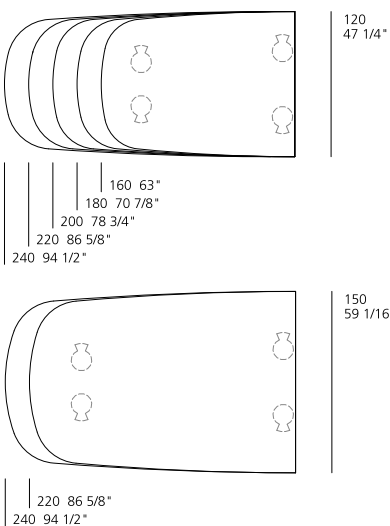

Integrated techni-station Compact with a power supply module and two slots for Keystone modules

The power solutions range from cable outlets to single table portals to integrated techni-stations with a range of different features.

All sizes in metric and imperial measurements. Subject to change.

---

## Shapes and formats

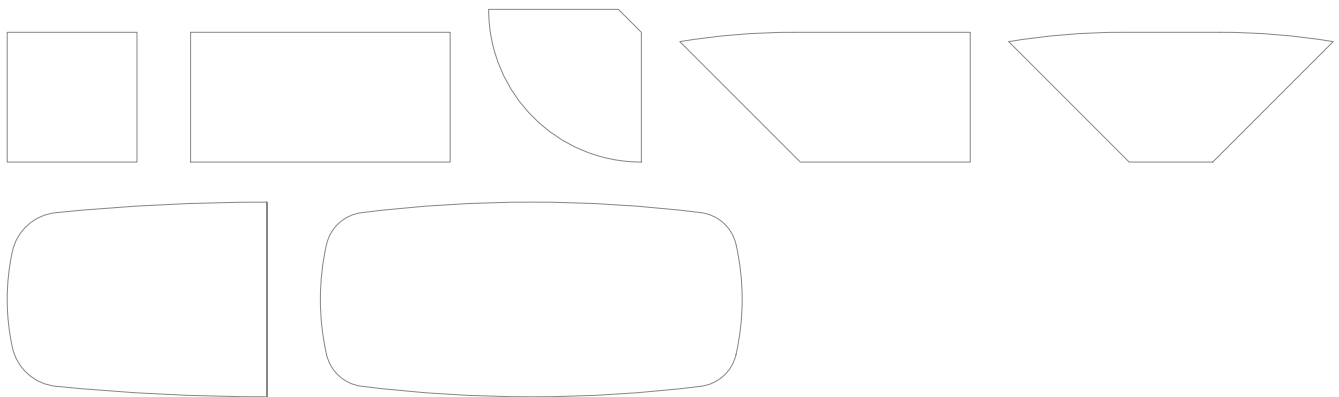

Square: 80 x 80 to 120 x 120 cm (31½" x 31½" to 47¼" x 47¼"), rectangular 120 x 80 to 220 x 150 cm (47¼" x 31½" to 86⅝" x 59"),  
90° circular segment: 133 x 80 to 161 x 100 cm (52⅜" x 31½" to 63⅝" x 39⅝"),  
semi-trapezoid: 180 x 80 to 220 x 100 cm (70⅞" x 31½" to 86⅝" x 39⅝"), trapezoid: 200 x 80 to 240 x 100 cm (78¾" x 31½" to 94½" x 39⅝"),  
semi-barrel shape: 160 x 107/120 to 240 x 134/150 cm (63" x 42⅞"/47¼" to 94½" x 52¼"/59"),  
barrel shape: 180 x 90 to 260 x 120 cm (70⅞" x 35⅜" to 102⅜" x 47¼"), table height: 73 cm (28¾")

---

## Edge profiles



Table top thickness 30 mm (1⅛"): Straight plastic lipping, straight wood lipping, chamfered wood lipping (edges on the side linked are always straight)

---

## Frame versions



Polished aluminum or high-lustre polished, coated black or white with a textured matt finish

---

## Table top groups



Laminate, soft-matte laminate, veneer version 1 or 2, wood decor on request

You can find all surfaces in our media center.

---

## Technical details



The frames on the starter and end table top panels are not flush with the edge on one side but are on the other so that the frame can be moved to link up the next segment. Middle elements can be linked on both sides and, in the case of stand-alone tables (which cannot be linked), neither of the frames on either of the short sides are flush with the edge to ensure plenty of leg room there as well.

The frames can be fitted without any tools required. Both sizes are made of die-cast aluminum and have two A-line-shaped, tapered legs which are connected to one another and come with two table top bearers at the top and four bolts each. The counter plates with bayonet connectors are fitted to the bottom of the table and made of gray-coated steel. A long brace between the table legs makes the frame wider. Multipurpose glides can compensate for differences in flooring height of up to 10 mm ( $\frac{3}{8}$ ").

To make handling Versa easier, the table tops are made of lightweight, fast-growing wood with a finger jointed middle section and, depending on the panel format, reinforced with underframes made of gray-coated steel. The sophisticated accessories are designed for easy handling and space-saving storage. Depending on elevator sizes, we recommend stowing the table tops in a vertical or horizontal position on trolleys.



Stand-alone table, model 638/51 with Graph office chair, model 302/8

## **Versa**

636 range. Design: Wolfgang C.R. Mezger 2018.

## **Wilkhahn Germany**

Wilkening + Hahne GmbH+Co. KG, Fritz-Hahne-Straße 8, 31848 Bad Münder

## **Wilkhahn worldwide**

Australia, Belgium, China, Deutschland, España, France, Hong Kong, Japan, Maroc, Nederland, Österreich, Polska, Schweiz, Singapore, South Africa, United Arab Emirates, United Kingdom, United States of America

**wilkhahn.com**